

浙江图谱智能科技有限公司 WWW.TOPOLOGY-TECH.COM	文件编号	TOP-DS102 -U-01-1.0
	版本号	1.0

## DS102 Display technical specifications

Product Name: Intelligent LCD display

Part Number: DS102

	Signature	Date
Write		
Checked by		
Approved by		

---

Zhejiang Topology Intelligent Technology Co., Ltd WWW.TOPOLOGY-TECH.COM

Room 702, Tower A, DIC, No.1190 Bin'an Rd. Hangzhou, Zhejiang

TEL: 0571-87633029

## Content

A.	Product introduce .....	4
	1 Product name and model .....	4
	2 Product Introduction .....	4
	3 Range of application .....	4
	4 Appearance and size.....	4
	5 Display coding rules.....	5
B.	Product manual .....	6
	1. Specifications .....	6
	2 Functional overview .....	6
	3 Installation .....	7
	4 Interface.....	8
	5 Definition of the buttons .....	9
	6 Operation.....	9
	6.1 Turn on/off.....	9
	6.2 Assist mode select.....	10
	6.3 Display information switch .....	10
	6.4 Walk assist mode.....	11
	6.5 Headlight (backlight) on/off.....	12
	6.6 Power indicator.....	12
	7 User settings .....	13
	7.1 enter setting.....	13
	7.2 unit setting .....	13

---

7.3 wheel diameter information.....	14
7.4 Speed limitation information.....	14
8.Data clearance .....	15
9 Error information.....	15
9.1 error shown .....	15
9.2 error code definition.....	16
10 wire definition .....	16
C. Note .....	16

## A. Product introduce

### 1 Product name and model

Intelligent LCD display, model: DS102

### 2 Product Introduction

- ✧ Simple and lightweight, separate installation bracket design
- ✧ High contrast 3.5 inch segment LCD screen
- ✧ Excellent outdoor design with IPx5 level waterproof
- ✧ Micro USB serial communication interface, convenient maintenance services

### 3 Range of application

Suitable for electric power assist bicycle in accordance with the standard of EN15194

### 4 Appearance and size

The material of product shell is ABS + PC. And the material of the window is tempered glass.



### 4.1 Switch appearance and dimensions

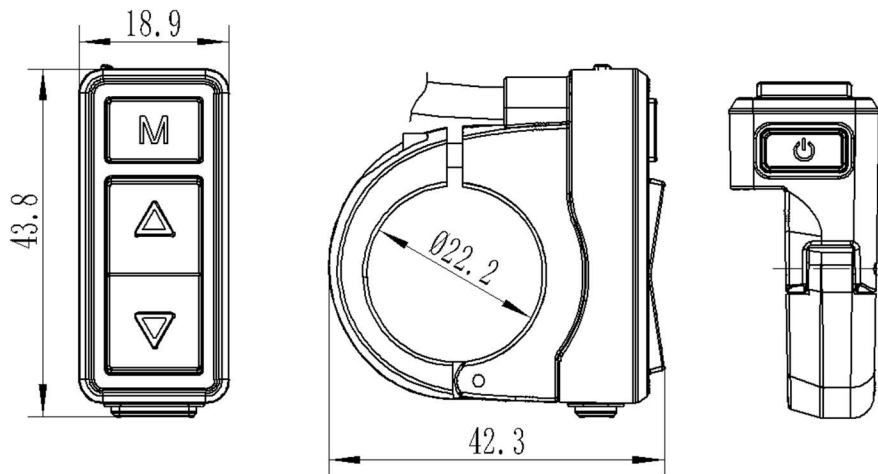

### 4.2 Display appearance and dimensions

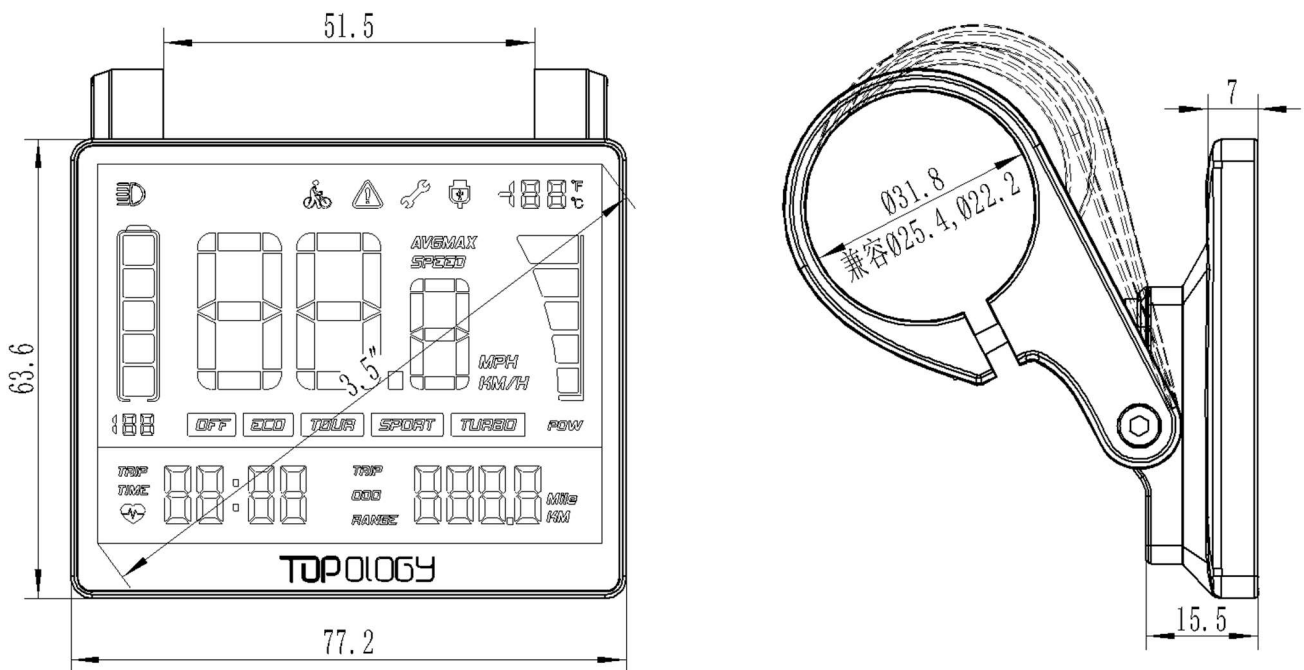

### 5 Display coding rules



As shown as above picture, C1 is the manufacture factory code  
1701 is the manufacture year and week number;

A means the hardware version;  
 001 is the firmware version number  
 0001 is the product serial number

## B. Product manual

### 1. Specifications

- ①Power supply: DC 24V/36V/48V
- ②Rated current: 18mA/36V
- ③Shutdown leakage current: <1uA;
- ④Screen specification: 3.5" LCD (FSTN)
- ⑤Communication method: UART
- ⑥Operating temperature: -20° C ~ 60° C
- ⑦Storage temperature: -30° C ~ 80° C
- ⑧Waterproof level: IP65

### 2Functional overview

- ①Four buttons, easy to operate
- ②Km / miles
- ③ Mileage display: Subtotal mileage (TRIP), total mileage (ODO)
- ④Speed display: Real-time speed (SPEED)、 maximum speed (MAX)、 average speed (AVG)
- ⑤Five stalls of power assist control: 0-4level (OFF-ECO-TOUR-SPORT-TURBO)
- ⑥Six levels of electricity instructions: 1-5level power, and under voltage prompts
- ⑦Headlight indicator: Headlight on/off status indication (need information from controller)
- ⑧Motor power display: Realtime display motor output power (segment display)
- ⑨Riding time (TRIP TIME) display
- ⑩6km/h walk assist function
- ⑪System maintenance instructions: Advice maintenance information based on riding distance and charge cycles
- ⑫UART communication port (Micro USB), convenient for system maintenance, parameter setting.

### ⑬ Error code indicator

## 3 Installation

①Determine if you need to select the corresponding mounting clamp and rubber clip ring according to the diameter of the handle bar (Applicable handle bar specifications:  $\Phi 22.2$ 、 $\Phi 25.4$ 、 $\Phi 31.8$ ). Open the display lock clamp and insert the rubber clip into the correct position of the lock clamp.

②Set the rubber ring in the bracket then assemble on the middle of the handle bar, adjust the angle of the display, make it easier to see the display screen when riding. After fixing the angle, tighten the screws. Tightening torque is 1N.m.

③Open the lock ring of the switch and set it in the prorated position on the left side of the handlebar. Adjust the angle of the switch, so that rider can see the switch and operate easily. (Applicable handle bar dimension is  $\Phi 22.2$ )

④Fix and tighten the handlebar fixing screw with M3Hex wrench, locking torque is 0.8Nm.

⑤Connect the display connector to the controller connector according to the label.

**Note: Damage caused by excessive torque is not covered by the warranty.**

## 4 Interface

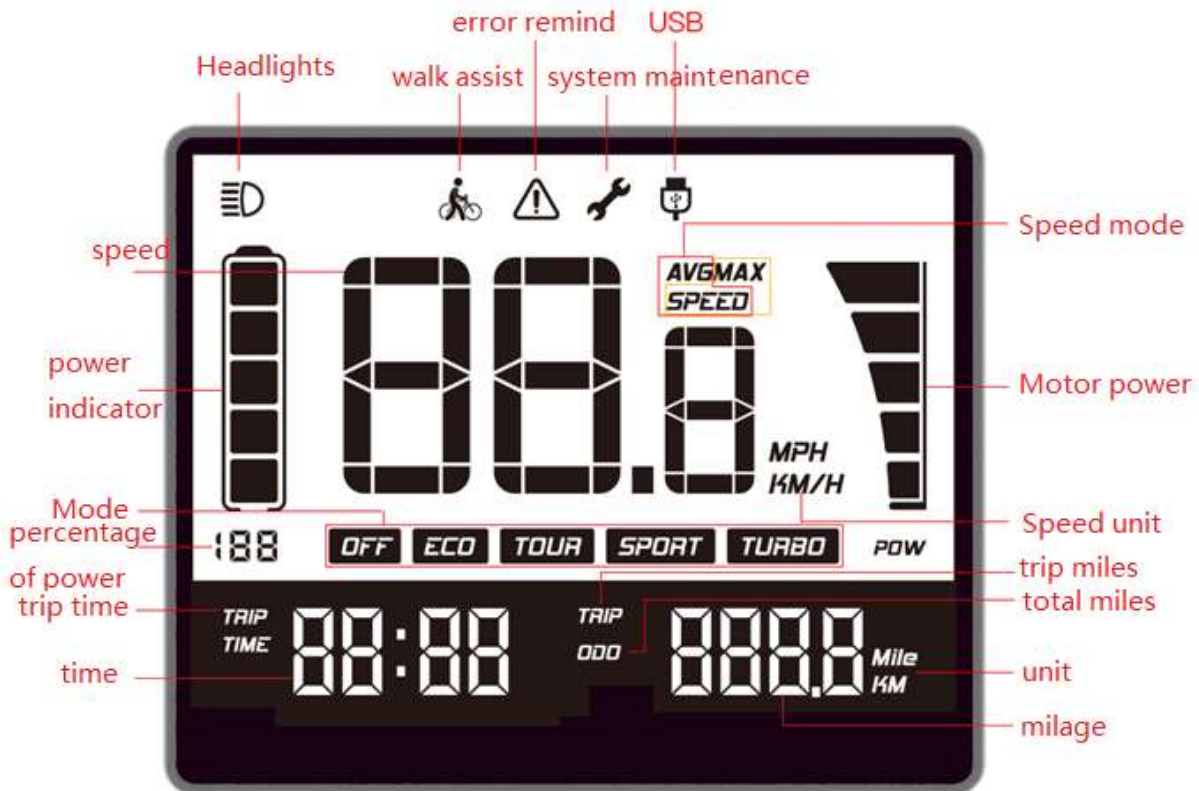

①Headlights: It shows when the headlamp is on. When the headlamp is turned off or does not have this function. The icon is not showed.

②Walk assist: It shows when 6KM walk assist mode. It is not showed on the rest of the states.

③Error remind: This icon flashes when the system is malfunction.It will not be seen when normal use.

④System maintenance:It shows when the system needs to be maintained (It shows when the mileage exceeds the set value or the number of battery cycles reaches the set value. If the customer does not request, it closed and was not shown as default.)

⑤USB: It shows when the display communicates with the PC, It is not showed on the rest of the states.

⑥Speed:When the display turned on, it shows the speed.

⑦ speed mode:SPEED indicates that the speed shown on the display is the current speed, AVG SPEED indicates that the speed shown is the average speed,MAX SPEED indicates that the speed shown is the maximum speed.



- ⑧ power indicator: Five levels power indicate and under voltage indicate.
- ⑨ Percentage of power: Indicate the percentage of the battery power.
- ⑩ Mode: Shows the current assist mode, range from low power assist to high power assist: ECO、TOUR、SPORT、TURBO, ECO as default; OFF indicate no power assist.
- ⑪ Speed unit: indicate the unit of the speed, KM/H or MPH.
- ⑫ Motor power: it has five sections to show motor real-time power.
- ⑬ Trip time: It shows the ridding time of the trip.
- ⑭ Time: it shows the riding time including hours and minutes
- ⑮ trip miles: When this icon is on, the number after the icon means the mileage of each trip, unit can be mile or Km.
- ⑯ ODO: When this icon is on, the number after the icon means the mileage of all trips; unit can be mils or Km.
- ⑰ unit: It's the unit of trip mileage and total mileage, with Mile and KM 2 options.
- ⑱ Mileage: It shows the number of the mileage. Trip mileage is accurate to one decimal place, the total mileage is accurate to single digits.

## 5 Definition of the buttons



On/off: , Mode: M, Adjust+: , Adjust -: 



## 6 Operation

### 6.1 Turn on/off

Maintain the normal connection of the display and the controller. Long press (2 seconds)  键 button when is display is off. Display shows the boot interface with all icons on. Then it enters the

basic interface to start work. Long press (2 seconds)  button when is display is on. Display closed. If no operation to the display and the speed is 0 for 5 minutes, display will turn off automatically.

### 6.2 Assist mode select

Press  or  to select the assist mode and change the assist power mode. There are 5 modes: OFF/ECO/TOUR/SPORT/TURBO. Default ECO mode when display turned on. OFF means no assist power. (assist mode select as below picture)

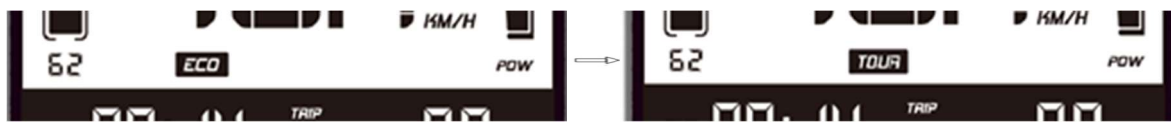

ECO Mode TOUR Mode

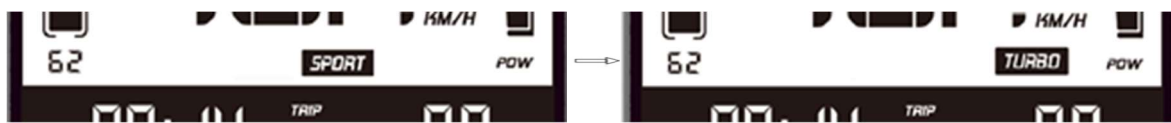

SPORT Mode

TURBO Mode



OFF Mode

### 6.3 Display information switch

Information switches from trip miles, average speed, max speed, total mileage by short press **M** when the display is on. It shows loop from current speed/trip miles (TRIP) -> average speed (AVG)、total mileage (ODO)->maximum speed (MAX)、trip miles (TRIP)->current speed/trip miles (TRIP). Mode switch as below pictures:

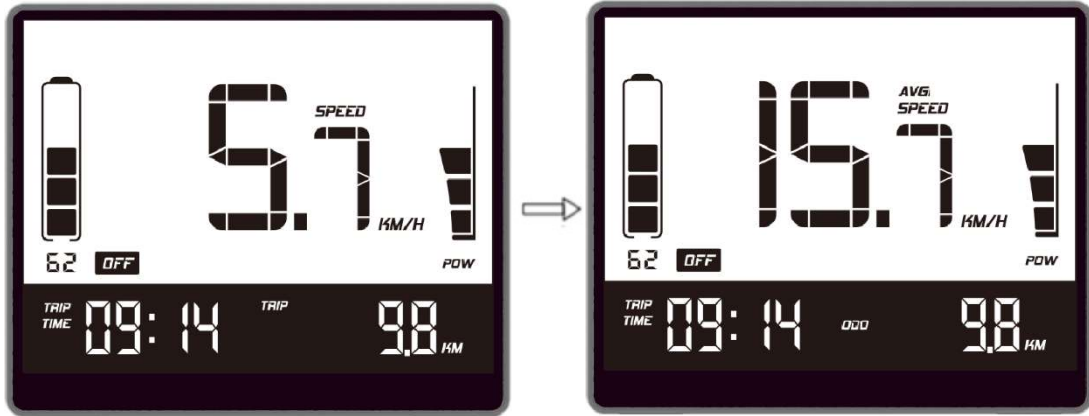

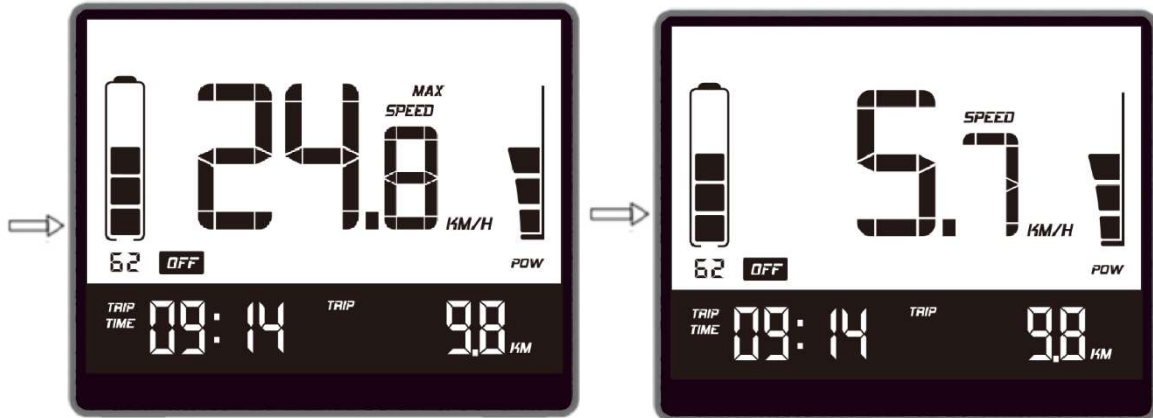

SPEED、TRIPAVG SPEED、ODO



MAX SPEED、TRIP SPEED、TRIP

### 6.4 Walk assist mode

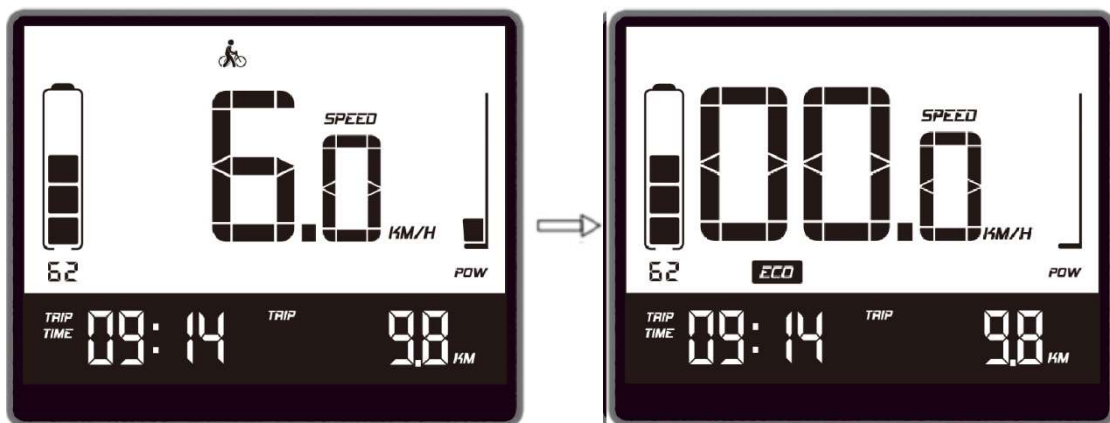

Long press  button for 2 seconds, bike entered walk assist mode. When  is shown, loose  button to exit walk assist mode .Walk assist mode switch as below pictures (only in the walk assist status):



Walk assist Mode

Normal Mode

### 6.5 Headlight (backlight) on/off

Long press  button for 1 second, the headlight is turned on (need support of controller). Headlight icon shows on the interface. At the same time, the backlight is on. Long press  button for 1 second again, the headlight is turned off. The icon of headlight is off. And the backlight is off.

### 6.6 Power indicator

When the battery is normal, the battery 5-segment LCD is displayed according to the time and the outer border is on. When the battery is exhausted, the 5 full LCD and the outer border of the battery indicator flashes, you need to charge immediately. The battery power is shown as below:

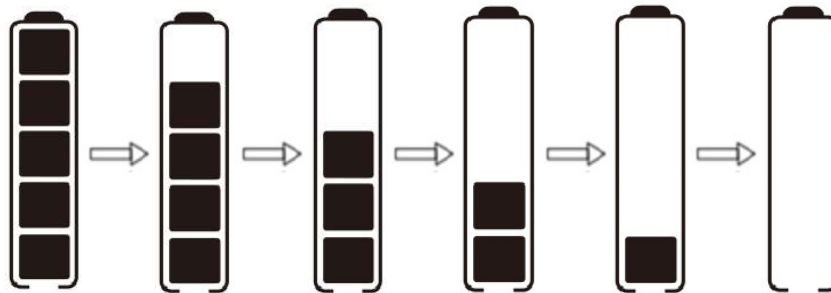

Percentage of battery power (C) and power level table

No.	Percentage on the display (SOC)	Level on the display	voltage (24V)	voltage (36V)	Voltage (48V)
1	$C \leq 5\%$	Outer border flashes	$U \leq 23.1$	$U \leq 33$	$U \leq 42.9$
2	$5\% < C < 15\%$	1 level power	$23.1 < U < 24.5$	$33 < U < 34.7$	$42.9 < U < 45.1$
3	$15\% \leq C < 35\%$	2 level power	$24.5 \leq U < 25.1$	$34.7 \leq U < 35.8$	$45.1 \leq U < 46.5$
4	$35\% \leq C < 55\%$	3 level power	$25.1 \leq U < 25.6$	$35.8 \leq U < 36.7$	$46.5 \leq U < 47.5$
5	$55\% \leq C < 75\%$	4 level power	$25.6 \leq U < 27$	$36.7 \leq U < 38.5$	$47.5 \leq U < 50.1$
6	$C \geq 75\%$	5 level power	$U \geq 27$	$U \geq 38.5$	$U \geq 50.1$

## 7 User settings

Setting items: unit, \*wheel diameter, \*speed limitation information. (\* means fixed items, do not provide user settings options)

### 7.1 enter setting

- ✧ 10 seconds within display turned on, long press **M** (3seconds) , system enter the data setting interface. On this status users can set and view the parameters of the display.
- ✧ Long press **M**(3 seconds) to exit and save the setting status.
- ✧ User settings interface state, if 10 seconds without the operation, display returns to normal riding state without saving the parameter settings.
- ✧ On data setting state, short press **^**/**v** to switch setting items
- ✧ Short press **M** to switch setting items circularly.

### 7.2 unit setting

Press **^**/**v** to select KM/H or MPH in unit setting interface. Press (short) **M** to switch setting interface.

UN: unit setting

**KM/H**: The unit of trip mileage and total mileage is Km. The unit of current speed, average speed; maximum speed is KM/H.

**MPH**: The unit of trip mileage and total mileage is Miles. The unit of current speed, average speed; maximum speed is MPH.

The interface is shown as below:

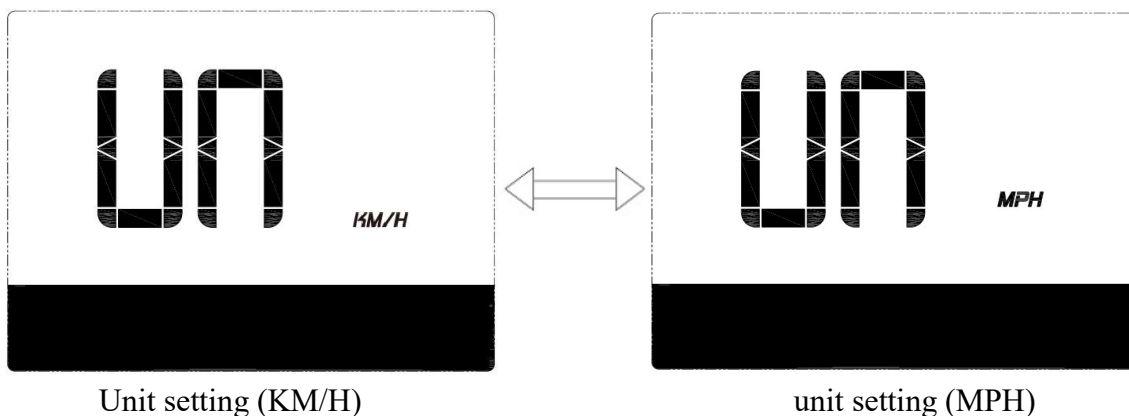

### 7.3 wheel diameter information

In wheel information interface, short press **M** to turn to speed limitation interface.

IN: wheel diameter information.

700C: means current display is setting for the bike of 700C wheel diameter.

Wheel diameter value can be set: 16inch、18inch、20inch、22inch、24inch、26inch、700Cinch、28inch、29inch.

The interface is shown as below:

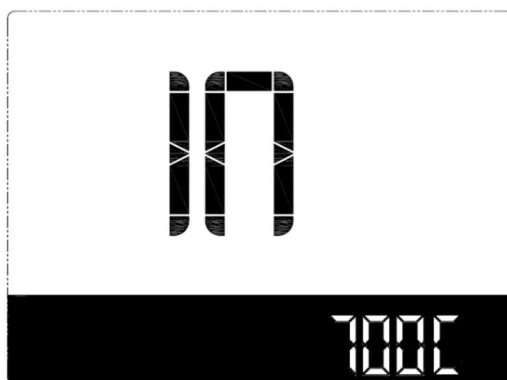

Wheel diameter information (700C)

### 7.4 Speed limitation information

In speed limitation interface, short press **M** to turn to unit setting interface.

SP: speed limitation information

25KM: maximum speed is 25KM/H;

The interface is shown as below:

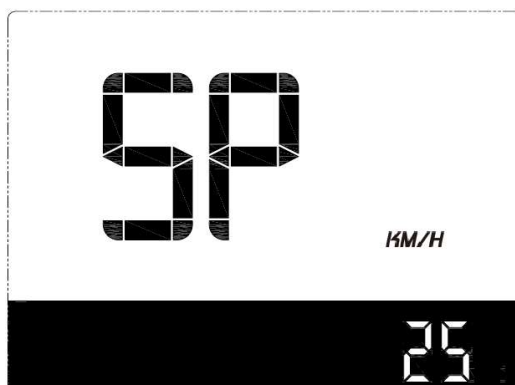

## 8.Data clearance

10 seconds after display turned on, long press **M**(3 seconds), enter the data clearance interface.  
Interface shows: speed, time, mileage, riding time, trip, unit.

Press (short) **M** to clean TRIP, TRIP TIME, AVG speed and MAX speed. Then display return to operation interface. Display will return to riding interface without data clearance if no operation in 5 seconds.

**Normal shutdown and power-down will not make the above data clear.**

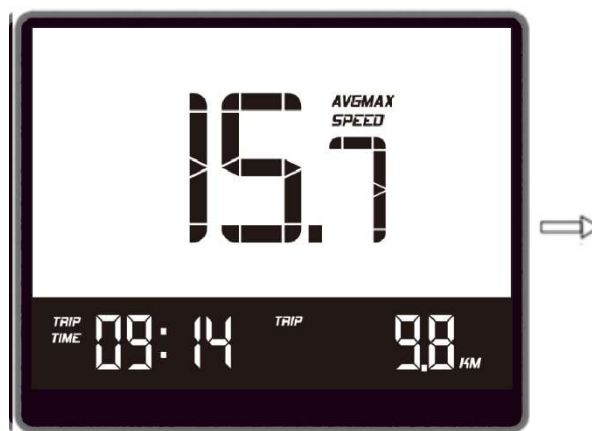

Data clearance interface riding interface

## 9 Error information

### 9.1 error shown

Presenting error code and error icon

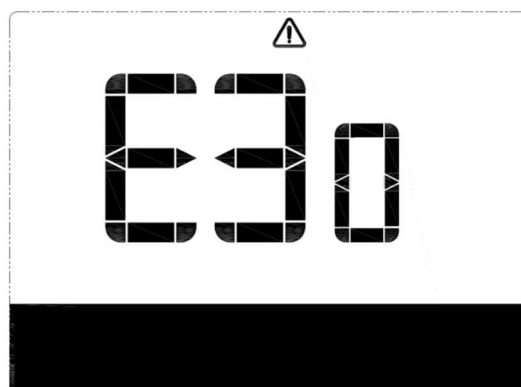

## 9.2 error code definition

Error code table:

Error code	Fault description	Checking method
"04" shown at speed	throttle doesn't turn back to zero position	Check if the throttle return to zero position
"05" shown at speed	throttle failure	check throttle
"07" shown at speed	overvoltage protection	check the voltage of the battery
"08" shown at speed	failure of motor's hall signal wire	check the motor
"09" shown at speed	failure of motor's phase wire	check the motor
"11" shown at speed	failure of the controller's temperature sensor	check the controller
"12" shown at speed	failure of the current sensor	check the controller
"13" shown at speed	failure of the temperature of the battery	check the battery
"14" shown at speed	failure of the temperature of the motor	check the motor
"21" shown at speed	failure of the speed sensor	check the position of the speed sensor
"22" shown at speed	failure of the BMS communication	check the battery
"30" shown at speed	communication failure	check the connector of the controller

## 10 wire definition

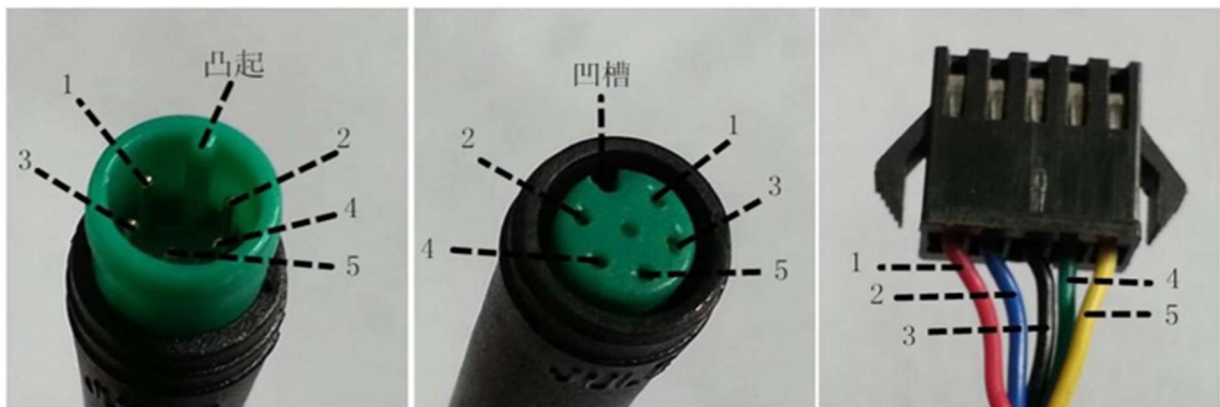

Wires out of the display

wires connect to the display

connector to controller

Table 1 wires definition

No.	Color	Function
1	Red(VCC)	VCC
2	Blue(Kp)	Power control wire of the controller
3	Black (GND)	GND of display
4	Green(RX)	Data receive of the display
5	Yellow(TX)	Data transmit of the display



## C. Note

- ✧ In the use of the display, pay attention to the security, do not plug the display in and out the when the power is on.
- ✧ Try to avoid use exposurein harsh environments like heavy rain, heavy snow, and strong sunlight
- ✧ When the display can't be used normally, it should be send to repair as soon as possible.