

LEADER FOX



Electric Bicycle Operating Instructions

Under the law, the dealer is obliged to attach the LEADER FOX Electric Bicycle Operating Instructions to every product



E – BIKE POWER RIDE

Acron



Introduction

Dear users,

Please read carefully all the information regarding your E-LF product to ensure optimal functioning of your e-bike. The following text containing a comprehensive description will provide you with information on all aspects and details (including installation, setting up and general use of the display) regarding the use of our display. This instruction document will also help you solve potential problems and failures.

What is an electric bicycle?

Electric bicycle is a conventional bicycle with an electric drive added to assist the rider. The motor function is actuated by pedalling, which is scanned by a special sensor installed in the pedal hub. Therefore, you have to keep pedalling on an e-bike, the motor is there only to help you. You can set an electric bicycle in motion also using a control button or an accelerator but only up to the maximum permitted speed of 6 KMPH (e.g. for walk assistance). The maximum speed of an e-bike with motor assistance is 25 KMPH, with a 10% tolerance (when this speed limit is reached, the motor switches off and you need to pedal just like with a regular bicycle). When your battery runs out of power or your motor is off, you can ride your electric bicycle as a conventional bike, without any resistance at all.

From the point of view of the Road Traffic Act, an electric bicycle whose features conform to European standard EN 15194-1 is regarded as a regular bicycle, i.e. you can ride on bike trails, do not need a driver's license and a helmet is mandatory only up to 18 years of age.

Description



Factors influencing the electric bicycle range

- 1. Rolling resistance of the tyres.** Leader Fox e-bikes are fitted with tyres with low rolling resistance and increased resistance to puncture. It is also important that the tyres are inflated properly. Therefore, if the tyres of your electric bicycle are underinflated, the range will decrease.
- 2. Weight of the electric bicycle.** The lower weight of the electric bicycle, the greater the range.
- 3. Battery status.** It depends on whether the battery was fully charged before your trip. It is also to be expected that the higher the number of discharge cycles the battery has undergone, the smaller capacity it has.
- 4. Profile and surface of the track.** The higher the elevation difference and the steeper hills you negotiate and the worse surface, the shorter the range.
- 5. Riding mode.** It depends on which of the three riding modes you have set.
- 6. Continuity of riding.** The more braking and acceleration, the shorter the range.
- 7. Air resistance.** For example, it depends on whether we ride a bicycle with low frame and sitting upright or whether we ride sporty bicycle with seat set to the same height as the handlebars.
- 8. Wind strength.** The stronger the wind we have back, the longer the range and vice versa.
- 9. Weight of the rider and load.** The greater the weight, the shorter the range.
- 10. External temperature.** The lower the temperature, the less battery capacity can be used while riding.

Electric set

M510

The system uses monitoring of torque, monitoring of speed of the pedal assist system and monitoring of real speed of wheels.

The system uses a dual protection feedback for measuring the speed signal to ensure safety and reliability of the system.

It has high starting torque, maximum torque of over 95 Nm, suitable especially for riding uphill.

It is highly efficient with low power consumption, long range, low noise levels, and smooth operation.

Description and scope of operation:

The motor unit works properly under the following operating conditions:

Temperature range - 20 + 55°C

Relative humidity - 15 – 95% RH

Maximum torque - ≥ 95

Weight - 3Kg

Noise - <55 dB

Dustproof/ waterproof - IP66

Certified - CE ROHS/ EN14766/ EN114764/ REACH

Description of the power unit is placed on the cover and shows the following information:

MM G522.250 15 033 F5 S329 0001

MM – Mid motor

G520 – Engine model

250 – Rated engine power

15 – Number of winding turns

033 – Connection combination sort

F5 – Measurement and control equipment number

S329 – Date of manufacture, indicating it is manufactured on March 29, 2018

0001 – Production serial number, ranging from 0000 to 9999, 0001 is the production serial number of the first motor

Safety instruction

Battery:

- Do not throw the battery into fire.
- Do not throw the battery into water.
- Do not use the battery for other appliances. It has been made specifically for this model.
- Do not dismantle or modify the battery.
- Do not connect the positive and negative poles of the battery.

Charger:

- Do not dismantle or modify the charger.
- Do not use the charger for other appliances. It has been made specifically for this model.
- Do not throw the charger into fire or water.
- Do not touch the charger with wet hands.
- Keep the charger from animals or children.
- Do not cover the charger.
- Do not use the charger if it is broken.

Charging set



Battery

Battery charging and maintenance:

Charge the battery in a dry environment to avoid short-circuit damage.

Charge the battery to at least 60% of the capacity once every 3 months even when the bicycle is not used.

Do not cover the battery or the charger.

Do not leave the battery constantly connected to the power source.

Do not use the battery for other appliances. It has been made specifically for this model.

Do not disassemble or modify the battery pack.

Do not throw the battery into fire or expose it to extreme temperatures.

Recharging time from zero to 100% is 1-7 hours.

Drive warranty:

The warranty applies to those drive parts that are not sensitive to improper handling (pack, electronics, charger, etc.); such parts are covered by a 24-month warranty.

The warranty does not apply to chemical parts of the battery and to capacity reduction due to normal use (39% after the expiry of two years); those parts are covered by a 12-month warranty.

Charging:

The battery is the most expensive part of an electric bicycle; therefore, pay increased attention during handling, charging and storage. The battery is sensitive to precise charging. Therefore, it is necessary to charge Li-Ion rechargeable batteries using only a charger supplied by us. Connect the charger to 220-240 V power outlet. 5A protected circuit is sufficient. The charger will automatically suspend charging when full capacity of all cells is reached.

We recommend discharging the battery in full after each ride to ensure that your battery will be up to its full capacity for your next ride. Charging the battery may last 1 to 5 hours depending on the condition of the battery cells. Charge it exclusively in covered dry areas (moisture and dripping water can damage the charger) at a temperature of 5 to 40°C.

The charging process is indicated by a red glowing LED. It will turn green when the battery is charged and the charging process is complete. The battery contains a charge-monitoring indicator (when the charge indicator button is pressed, the light indicator will come on). Always switch off the battery when finished riding the bike.

Normal battery behaviour:

If the motor stops running smoothly and switches to intermittent operation, it could be a sign of low battery capacity. In that case switch off the electric drive system and continue without motor assistance, as if riding a conventional bicycle.

Battery warming is normal and does not indicate any defect. The battery is protected by a temperature sensor and switches off automatically in case of excessive overheating. Wait until the battery cools down to its normal operating temperature and then ride on.

If you feel your total battery capacity has dropped, it could be caused by charging or operation in suboptimal climatic conditions. Carry out 3 full charging cycles. Fully discharge the battery while riding and then charge to its full capacity at room temperature.

If the charge indicator shows that the battery is discharged, there is still a minimum voltage level in it which protects it against damage but is not enough to power the electric bicycle. Recharge the battery as soon as possible. Never leave the battery fully discharged, it could result in its damage.

In the case, that the battery will be turned on more than 30 min and bike will not be used, the battery will be automatically switched off.

Proper care of the battery prolongs its life.

LCD display



KEY-DISP

eBike Display

User Manual

KD686

Product name and model number

Intelligent ebike color display; Model: **KD686 (CAN BUS)**

Specification parameters

- 2.0"IPS color screen
- 36V/48V/52V power supply
- Rated operating current of the display: 22mA
- Shutdown leakage current: <1uA
- Operating temperature:-1-10~60℃
- Storage temperature:-2-20~70℃℃

Appearance size

Physical drawing and dimensional drawing of the display (unit: mm)

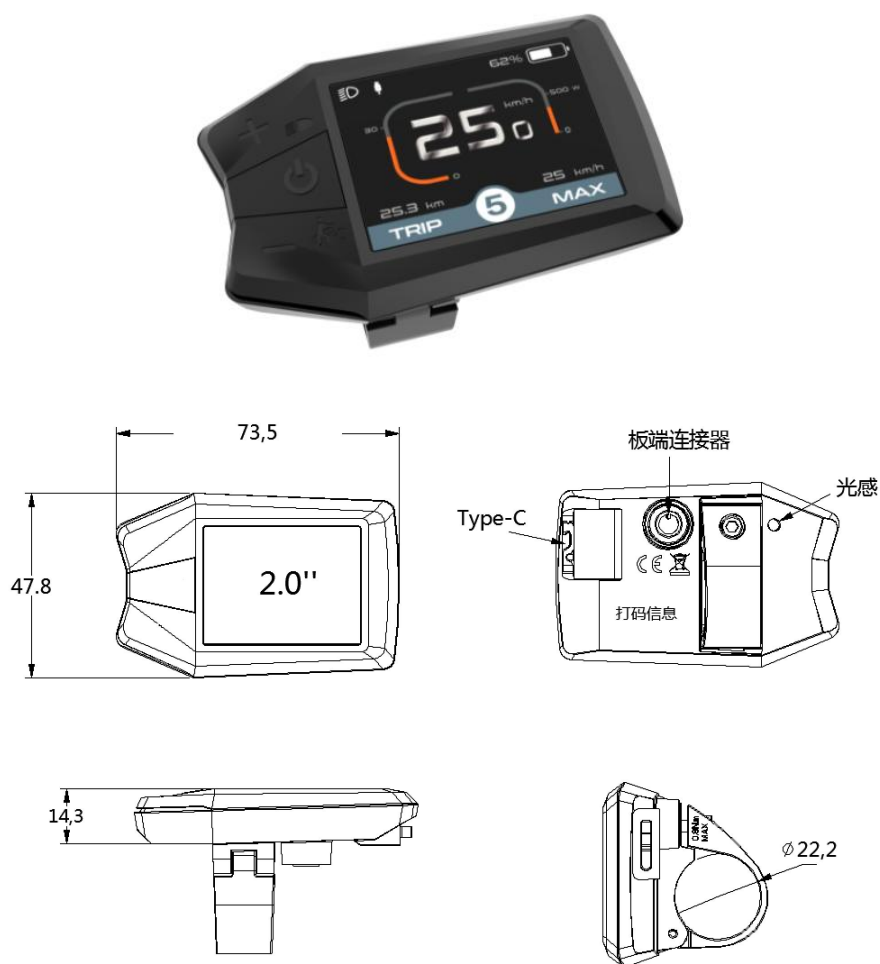

The KD686 display provides a variety of functions to meet your riding needs, including:

- Smart battery indicator: real-time voltage/battery percentage
- Intelligent display: single mileage TRIP, total mileage ODO, real-time

SPEED, maximum speed MAX, average speed AVG, riding time, remaining mileage (km), calories (KCal)

- Motor output power display
- Assist level adjustment and display
- Backlight control and headlight display
- Walk mode
- Type-C charging function
- Light sensing function
- Multiple parameter settings (such as: single mileage clear, backlight, metric and inch system, power setting, gear setting, wheel diameter speed limit setting, boot password setting, etc.)
- Restore the factory default settings
- Error code display
- Bluetooth function (optional)

Display area

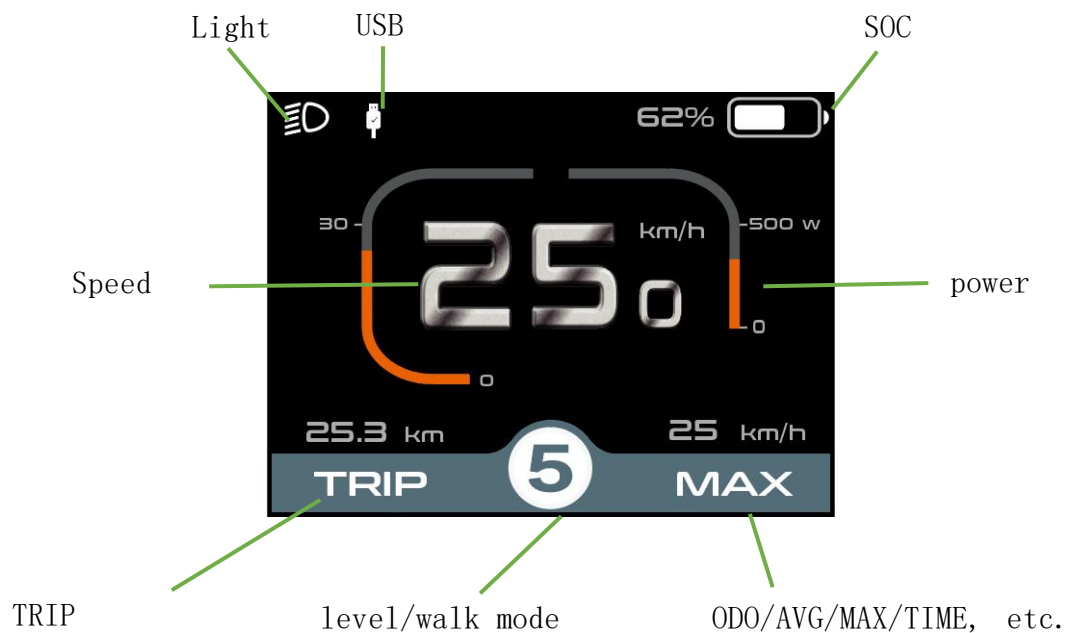

◆ Button definition

THERE are 3 buttons on the KD686 display, including: on/off button, plus button/headlight button, minus button/boost button; IN the subsequent instructions, the on/off button is replaced by the word "ON/OFF"; the plus button/headlight button is replaced by the word "UP"; minus button/headlight button is replaced by the word "UP".The key/booster key is replaced by the word "DOWN".

General operation

◆ Power on/off

After long-pressing the power button, the display starts to work and provides the working power of the controller. In the boot state, press and hold the power button to turn off the power of the electric vehicle. In the shutdown state, the display no longer uses the battery power supply, and the leakage current of the display is less than 1uA.

■ If the electric vehicle is not used for more than 5 minutes, the display will automatically turn off.

◆ Display interface

After the display is turned on, the display displays real-time speed, single mileage, total mileage, power, battery, and gear by default.

Press the "ON/OFF" button to switch between the total mileage ODO (km), the maximum speed MAX (km/h), the average speed AVG (km/h), the time (min), the remaining mileage (km), and the calories (KCal).



Display interface switching

◆ Walk mode

Short press the "DOWN" button to the booster gear "🚲", press and hold the "DOWN" button, and after 2 seconds, the electric vehicle will enter the electric booster state. Electric vehicles travel at a uniform speed of not more than 6Km/h. Release the "DOWN" button and the electric vehicle will immediately stop the power transmission and return to 0 gear.



Walk mode

◆ Light sensing function, and manually turn on/off the backlight

The display has a photosensitive function, which can sense the light and dark conditions of external light, and automatically turn on/off the headlights. When the external light is insufficient or when driving at night, the backlight of the display **dims**, and the controller is notified to turn on the headlights at the same time; when the external light is sufficient, the backlight of the display **turns on**, and the controller is notified to turn off the headlights at the same time.

Manually press **and hold the UP** button for more than 2 seconds, the display performs the function of turning on/off the headlights, and the light sensing function fails at the same time.



Turn on the backlit display interface

◆ Assist level selection

Short press **the "UP" or "DOWN"** button to switch the PAS level of the ebike and change the motor output power. The default output power range of the display is PAS level 0-5 , 0- zero power output, 1- the lowest power, and 5- the highest power.

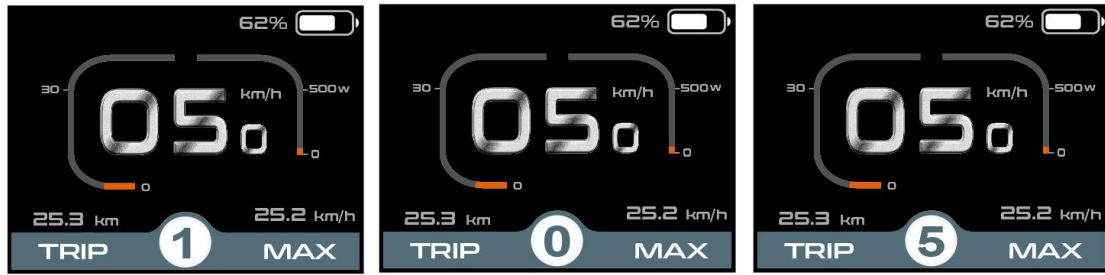

Booster gear selection interface

◆ **Battery display**

display battery voltage 36V; 36V voltage segmentation:31.5 V-34.5 V-35.6 V-37.4 V-39.2V



Battery SOC Interface

◆ **Motor power indication**

The motor output power is shown in the figure below.



Motor power display interface

◆ **Error code display**

When the electric vehicle's electronic control system fails, the display will display an error code. For the definition of the error code, please refer to **Appendix 1** for details.



Error code display interface

■ When the error code is displayed, please resolve the fault in time. After the fault occurs, the ebike will not be able to travel normally.

General parameter settings

In the turned-on state, the vehicle is stationary, and at the same time press and hold the “UP” and “DOWN” buttons for more than 2 seconds, the display enters the setting interface;

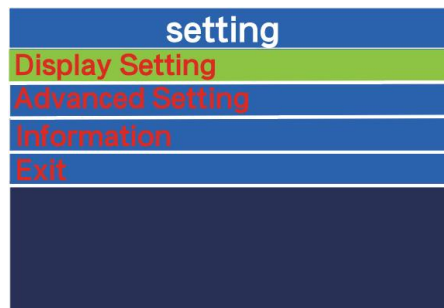

● Display Setting

◆ TRIP RESET

Short press “UP” or “DOWN” to switch “NO (not clear)” and “YES (clear)”; (Clear data includes maximum speed (MAX), average speed (AVG), single mileage (TRIP), riding Time (Time)), after confirming, short press “ON/OFF” again, save and exit to “Trip reset”, the display defaults to “Trip reset-NO”.

Display Setting	
Trip reset	No
Unit	Metric
Brightness	100%
SOC View	percent
Auto Off	5Min
AL Sensitivity	5
Set Voltage	36V
BACK	



Display Setting	
Trip reset	YES
Unit	Metric
Brightness	100%
SOC View	percent
Auto Off	5Min
AL Sensitivity	5
Set Voltage	36V
BACK	

Single mileage clear setting

◆ unit

Short press“UP”or“DOWN”to select "UNIT", short press“ON/OFF”to enter the settings,“UP” 或 “DOWN”select "Metric" (kilometer)/"Imperial (mile)" by short press "UP" or "DOWN", short press“ON/OFF”to save and exit to“Unit”.

Display Setting	
Trip reset	No
Unit	Metric
Brightness	100%
SOC View	percent
Auto Off	5Min
AL Sensitivity	5
Set Voltage	36V
BACK	



Display Setting	
Trip reset	No
Unit	Imperial
Brightness	100%
SOC View	percent
Auto Off	5Min
AL Sensitivity	5
Set Voltage	36V
BACK	

Imperial and metric unit conversion setting interface

◆ Brightness

Short press“UP”or“DOWN”to select “Brightness”, short press“ON/OFF”to enter the settings, by short press“UP”or“DOWN”,the backlight brightness range is“100%-75%-50%-30%-15%” 5 levels of brightness, 100% corresponding to the highest brightness, 15% corresponds to the lowest brightness; short press“ON/OFF”to save and exit to "Brightness".The default backlight brightness of the display is “100%”.

Display Setting	
Trip reset	No
Unit	Metric
Brightness	100%
SOC View	percent
Auto Off	5Min
AL Sensitivity	5
Set Voltage	36V
BACK	



Display Setting	
Trip reset	No
Unit	Metric
Brightness	75%
SOC View	percent
Auto Off	5Min
AL Sensitivity	5
Set Voltage	36V
BACK	

backlight brightness setting interface

◆ SOC View

Short press“UP”or“DOWN”to select "SOC View", short press“ON/OFF”to enter the settings, and short press“UP”or“DOWN”to switch to: "Voltage (voltage display)"; the display defaults to “Percentage”, short press“ON/OFF”Save and exit to "SOC View”.

Display Setting	
Trip reset	No
Unit	Metric
Brightness	100%
SOC View	percent
Auto Off	5Min
AL Sensitivity	5
Set Voltage	36V
BACK	



Display Setting	
Trip reset	No
Unit	Metric
Brightness	100%
SOC View	Voltage
Auto Off	5Min
AL Sensitivity	5
Set Voltage	36V
BACK	

Battery percentage/voltage display setting interface

◆ **Auto OFF**

“Auto Off” means that the display is automatically turned off when the time is set. Short press “i” to enter the settings, select the automatic shutdown time by short pressing “UP” or “DOWN”, the range is “OFF, 1-99(Min)”, short press “i” to save and exit to “Auto Off”. The default automatic shutdown time of the display is 5 minutes.

Display Setting	
Trip reset	No
Unit	Metric
Brightness	100%
SOC View	percent
Auto Off	5Min
AL Sensitivity	5
Set Voltage	36V
BACK	



Display Setting	
Trip reset	No
Unit	Metric
Brightness	100%
SOC View	percent
Auto Off	8Min
AL Sensitivity	5
Set Voltage	36V
BACK	

Automatic shutdown time setting interface

◆ **AL sensitivity**

“AL Sensitivity” indicates the setting of light sensor sensitivity. Short press “i” to enter the settings, and select the light sensitivity value by short pressing the “UP” or “DOWN” button. The range is “5-4-3-3-2-1-OFF”, short press “i” to save and exit to “AL Sensitivity”. The default light sensitivity of the display is 5.

Display Setting	
Trip reset	No
Unit	Metric
Brightness	100%
SOC View	percent
Auto Off	5Min
AL Sensitivity	5
Set Voltage	36V
BACK	



Display Setting	
Trip reset	No
Unit	Metric
Brightness	100%
SOC View	percent
Auto Off	5Min
AL Sensitivity	3
Set Voltage	36V
BACK	

Light sensitivity setting interface

◆ **Set voltage**

Short press “UP” or “DOWN” to select “Set Voltage”, the default 36V voltage of the display cannot be changed.

Press and hold the “ON/OFF” button to return to the main interface or go BACK to the main interface via “BACK” →.

Display Setting	
Trip reset	No
Unit	Metric
Brightness	100%
SOC View	percent
Auto Off	5Min
AL Sensitivity	5
Set Voltage	36V
BACK	



Display Setting	
Trip reset	No
Unit	Metric
Brightness	100%
SOC View	percent
Auto Off	5Min
AL Sensitivity	5
Set Voltage	48V
BACK	

Battery voltage

●Advanced Setting

In the **DisPlay** Setting menu, select **EXIT**, short press **“ON/OFF”** to return to the main interface and select **“Advanced Setting”**, and short press **“ON/OFF”** to enter **Advanced Settings** menu;

◆Max pas

Short press **“ON/OFF”** to determine, short press **“UP”** or **“DOWN”** to switch gears **“0-3、0-5、0-7、0-9、”** 4In this mode, short press **“ON/OFF”** to save the settings, and return to the settings item selection interface.

Advanced Setting	
Max pas	0-5
Wheel size	28.0Inch
Speed Limit	25km/h
Current limit	15A
Speed sensor	6
Assistant Num	12
Throttle-6km	OFF
Throttle-PAS	OFF



Advanced Setting	
Max pas	0-3
Wheel size	28.0Inch
Speed Limit	25km/h
Current limit	15A
Speed sensor	6
Assistant Num	12
Throttle-6km	OFF
Throttle-PAS	OFF

Gear setting interface

◆Wheel size

“Wheel” represents the wheel diameter, the default is **“26Inch”**, which cannot be adjusted. Press and hold the **“ON/OFF”** button to return to the main interface or go **BACK** to the main interface via **“BACK”** →.

Advanced Setting	
Max pas	0-5
Wheel size	26.0Inch
Speed Limit	25km/h
Password	>
Battery info	>
Controller info	>
Language	English
BACK	

Wheel size

◆Speed limit setting

“Speed Limit” represents the speed limit, the default is **“25km/h”**, which cannot

be adjusted. Press and hold the "ON/OFF" button to return to the main interface or go BACK to the main interface via "BACK"→.

Advanced Seeying	
Max pas	0-5
Wheel size	26.0Inch
Speed Limit	25km/h
Password	>
Battery info	>
Controller info	>
Language	English
BACK	

Speed limit

◆ Power-on password setting

Short press "UP" or "DOWN" to select "Password", short press "ON/OFF" to enter setting. Enter setting, select Start PassWord by short press "UP" or "DOWN", short press "ON/OFF" to switch between "PassWord" and "Password". Short press "ON/OFF" to switch "OFF"/"ON", the following is the specific switching method. There is no power-on password by default.

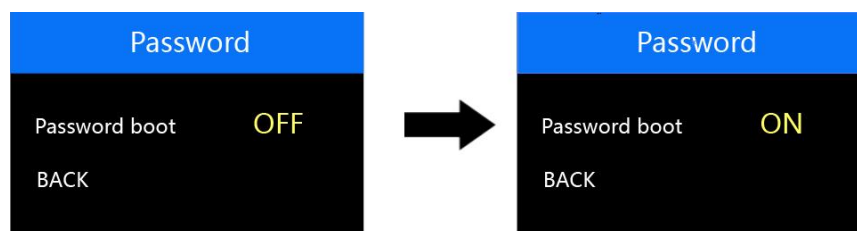

Power-on password setting screen

◆ Power-on password enable

In the "PassWord boot" interface, select "ON", press "ON/OFF" to confirm, the interface prompts to enter the password, press "UP" or "DOWN" to increase/decrease the input value, press "ON/OFF" to shift the value, after the 4-digit password input, press "ON/OFF" to shift the value. UP" or "DOWN" key to add/subtract the input value, short press "ON/OFF" key to shift the value, after 4-digit password input, short press "ON/OFF". "ON/OFF" to confirm; the interface prompts to enter the password again, after the two inputs are the same, the system prompts the password set successfully, if the two inputs are not the same, then you need to repeat the first step to enter a new password and then confirm that the password is set successfully, the 2S interface automatically jumps to the original setup interface.

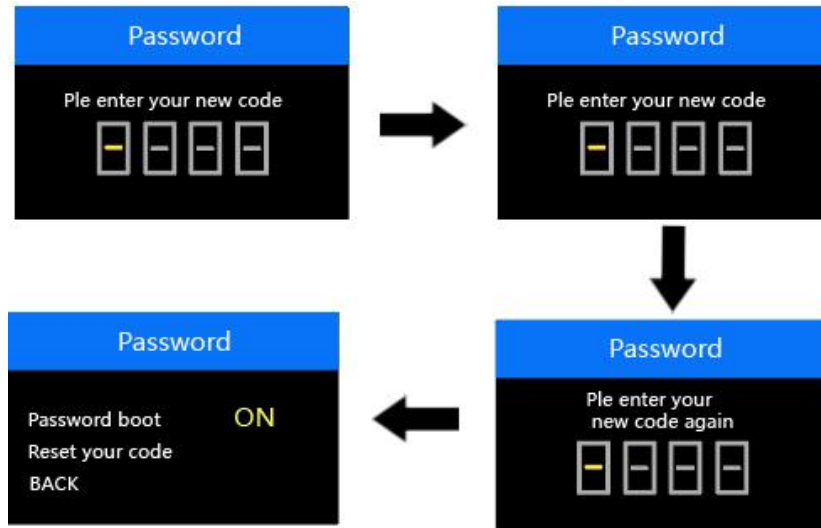

Password Enable Confirmation Screen

◆ **Power-on password change**

After opening the password, "Pass word" interface will add "Reset your code" option, short press "UP" or "DOWN" to select "Reset Password", short press "ON/OFF" again to make sure. Short press "UP" or "DOWN" to select "Reset Password", short press "ON/OFF" again to make sure, at this time, the interface prompts you to enter the current password, the password is entered correctly, the interface prompts you to enter the new password. The interface prompts you to input the new password after the password is input correctly, and the operation will be the same as the new password, after the password is modified successfully, the 2S interface will automatically jump to the original setting interface.

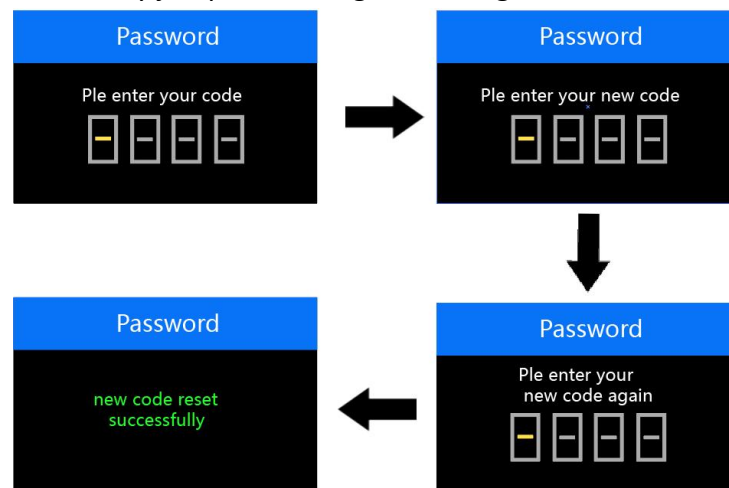

Password change screen

◆ **Disable Password**

After selecting "OFF" in the "PassWord" interface, press "ON/OFF" briefly to make sure, at this time, the interface prompts you to input the password, after the

password is correctly input, the interface prompts you that the password function is successfully turned off. After the password is correctly entered, the interface prompts that the password function is closed successfully, and the interface automatically jumps to the original setting interface after 2S.

Long press "ON/OFF" to exit to the main interface or "BACK" to exit to the setting interface, short press "ON/OFF" to select EXIT to return to the main interface.

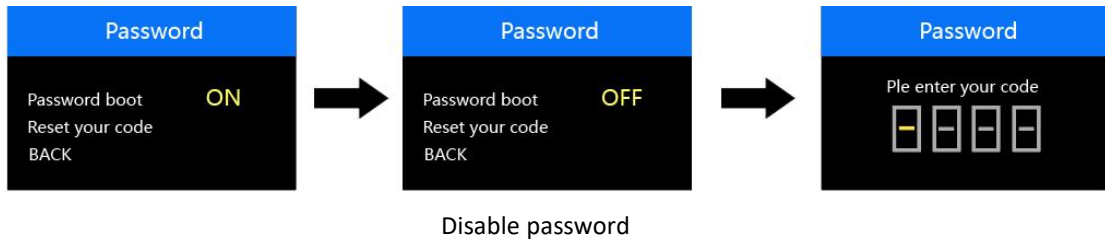

◆ Battery information

“Battery info” stands for battery information. You can view the battery information by entering this page. Press and hold the "ON/OFF" button to return to the main interface or go BACK to the main interface via "BACK" →.



◆ Controller information query

“Controller info” represents controller information, and you can view controller information by entering this interface. Press and hold the "ON/OFF" key to exit to the main interface or through "BACK" → exit to the main interface.

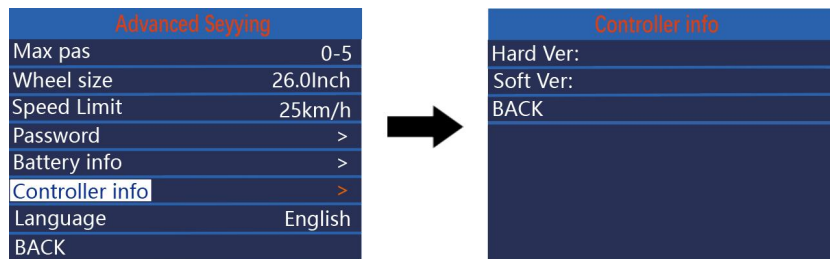

◆ Language selection

“Language” represents the language setting. Short press “UP” or “DOWN” 选 to select “Czech”, “French”, “German”, “English” and short press “ON/OFF” to confirm.

The default is English. Long press "ON/OFF" to exit to the main interface or exit through "BACK". Go to the settings interface.

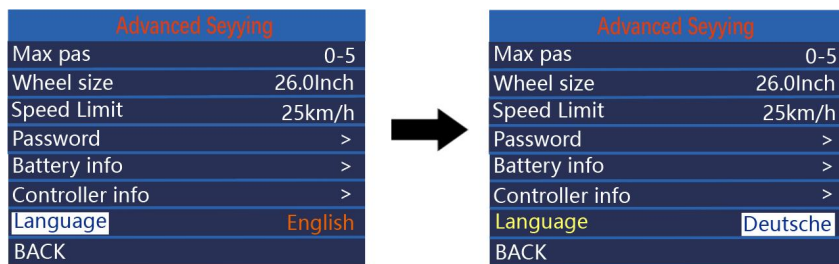

Language selection

■ If no operation is performed within 1 minute, the display will automatically exit the setting state.

◆ display connector pinout:

Junlet 5-pin male, model: JL-F39-Z508JG



线色功能
 红 电源正极
 蓝 锁线
 黑 电源负极
 绿 通讯RX
 黄 通讯TX

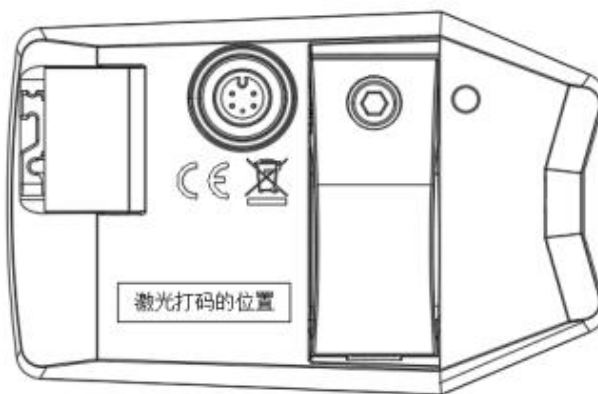

display connector pinout table

Serial	Name	function
1	VCC	display power cord
2	KP	controller power supply control line
3	GND	display ground
4	CAN-H	CAN-H
5	CAN-L	CAN-L

Appendix 1: Error Code Definition Table

Error code	definition
31	low voltage protection
32	Over voltage protection
08	Motor hall failure
09	Motor phase line failure
25	torque sensor failure
30	Communication fault between the display and the controller

Quality commitment and warranty scope

1. Warranty information:

1. For failures caused by quality problems of the product itself under normal use, the company will be responsible for granting a limited warranty during the warranty period.

2. The warranty period of the product shall be within 24 months from the time the display leaves the factory.

2. The following conditions are not covered by the warranty

1. The shell is opened

2. The connector is damaged

3. After the display leaves the factory, the shell is scratched or the shell is damaged.

4. The display pinout is scratched or broken

5. Failure or damage caused by force majeure (such as fire, earthquake, etc.) or natural disasters (such as lightning strikes, etc.)

6. The product is out of warranty

Warnings

Pay attention to the safety of use during use, and do not plug in and unplug the display while it is powered on.

- ◆ Try to avoid bumps on the display.
- ◆ Regarding the background parameter settings of the display, please do not change it at will, otherwise normal riding cannot be guaranteed.
- ◆ When the display cannot be used normally, it should be repaired as soon as possible.

Maintenance

Regular maintenance:

- maintain all components of the electric bicycle clean
- use only the recommended and tested cleaning materials
- regularly lubricate the chain with suitable oils
- in winter, clean the electric bicycle after each ride and pay increased attention to removing salt from battery contacts and other connectors
- while handling the electric bicycle, make sure the cables of the electric system are not damaged. Damaged cables pose a risk of electric shock
- regularly check all connections for correct tightening and brakes for correct function. Check also individual parts of the electric bicycle for damage. For example: cracks on the frame, fork, handlebars, stem, damage to cables, damage to battery pack, etc.

Battery transport:

Battery transport is subject to the requirements of regulations on dangerous goods. Private users may transport undamaged batteries on roads without having to conform to other conditions.

In case of transport by commercial users or by third parties it is necessary to comply with special packaging and marking requirements (e.g. ADR regulations)

Batteries should only be sent if the battery pack is undamaged. Plug loose contacts and pack the battery to prevent its movement in the packaging. Notify the forwarding service that the transport concerns dangerous goods.

Battery storage:

Store the battery in a dry and well-ventilated place, out of reach of direct sunlight and other heat sources. In case of cold storage it is necessary to let the battery warm up to normal room temperature (20°C) before putting into operation.

Never leave the battery fully discharged. It could result in its permanent damage. For long-term storage keep the battery fully charged. However, do not store it while permanently connected to the charger or installed in the electric bicycle.

Li-Ion batteries are fully recyclable. After expiry of the battery life you can return it at any collection point or your dealer.

If you use an e-bike in hard conditions (long-term use of the maximum assistance), for longer ride at higher temperatures (30 ° C or above), in direct sunlight or when the battery is partially discharged and a combination of these situations is it possible that bike will automatically switch off. This is a fuse protecting the control unit against burning. We recommend stop the ride and let the bike (control unit) cool down a little bit. This is not a defect.

Possible problems and their solutions

In case of system failure perform its diagnostics or contact your dealer.

The control LCD display is not on:

- always make sure the battery is charged
- check whether the battery is inserted correctly, whether the battery switch is on
- check the connections of the control unit and the display

The motor does not start when the walk assistance button is pressed

- check the connection of the motor cable (at the motor and the control unit)
- check the connections of the control unit and the display

The motor does not start when rotating the pedal cranks (pedalling)

- check the connection of the pedalling sensor to the control unit
- check the distance between the pedalling sensor and the magnet disk (max. 4 mm)
- check whether the disk is firmly attached to the central axle and does not spin freely
- in case of use of compact-type pedalling sensor

Warning

When there is a problem with the electric bicycle, it can show error messages. LCD display will show the icon and an error code will be displayed on the speed display. Error codes are marked from 01 E~FF E; see their meaning in the table below.

Error code	Description	Solution
6	Low battery voltage	Check battery voltage
7	High voltage protection	Check battery voltage
8	Hall probe error	Check motor
9	Three-phase supply error	Check motor
11	Overheating controller sensor	Check controller
12	Overvoltage controller sensor	Check controller
13	Overheated battery	Check battery
21	Speed sensor error	Check the position of the sensor
22	BMS communication error	Change battery
30	Communication error	Check connectors

Electric set warranty

Complaint procedure:

Submit any complaints concerning the electric set or the battery to your dealer.

When filing a complaint, submit a proof of purchase and a warranty certificate with the registered serial number of the battery and indicate the reason for the complaint and a description of the defect.

Warranty conditions:

24 months for electric bicycle components – applies to manufacturing and material defects beyond normal wear and tear caused by use.

12 months for battery life – the nominal battery capacity does not drop below 70% of the total capacity over 12 months from the sale of the electric bicycle.

Warranty conditions:

The electric set must be used exclusively for the purposes it is intended for.

The electric set must be used, stored and maintained in accordance with these Operating Instructions.

A warranty claim shall expire:

If it is found out that the damage to the product is due to the user's fault (accident, inexpert handling beyond the framework of these Operating Instructions, tampering with the structure of the electric bicycle or connection of the electric system, improper storage, etc.).

Expiry of the warranty period.

The warranty only applies to the first owner

Warning

If you do not understand any of the points in these Operating Instructions, please contact the dealer for explanation. Please read the whole manual!

Do not lend the e-bike to persons not briefed in its use and operation. Complaints resulting from improper handling will not be accepted.

The LF Energy electric bicycle is not intended for use by children under 15 years of age. Likewise, the electric bicycle cannot be used by persons unable to pedal or handle it independently. The manufacturer is not to be held responsible for any potential injuries or damage to the bicycle!

Ideal weather conditions for using an electric bicycle are dry days, when the outdoor temperature is above 10°C. When used at lower temperatures, the battery discharges faster due to physical phenomena. Using the electric bicycle at temperatures below 0°C is not recommended.

Do not expose the bicycle to direct sunlight as it is fitted with a protective temperature sensor for the electric motor.

Never submerge the battery, the charger and other electric components in water or another liquid.

Never wash the electric bicycle in a pressure washer (WAP) and always remove the battery before washing

It is forbidden to tamper with the connections of the electric motor, the control unit and the battery. Violating this section may result in the warranty not being acknowledged or in irreversible damage to the electric bicycle.

DO NOT USE chargers and components other than the ones included with the electric bicycle.

We cannot be held responsible for damage caused by use of other non-approved goods

LEADER FOX



Enjoy many pleasant and safe kilometres on your new electric bicycle.

Your Leader Fox Team



**Czech brand of electric bicycles.
BOHEMIA BIKE**

Address

Pujmanové 1753/10 a
140 00 Praha 4 - Nusle

Development, design and manufacturing

Okružní 697
České Budějovice 37001

Phone: 388 314 885

Email: info@leaderfox.cz

