

LEADER FOX



Electric Bicycle Operating Instructions

Under the law, the dealer is obliged to attach the LEADER FOX Electric Bicycle Operating Instructions to every product



E – BIKE POWER RIDE

Lucas



Introduction



Dear users,

Please read carefully all the information regarding your E-LF product to ensure optimal functioning of your e-bike. The following text containing a comprehensive description will provide you with information on all aspects and details (including installation, setting up and general use of the display) regarding the use of our display. This instruction document will also help you solve potential problems and failures.

What is an electric bicycle?



Electric bicycle is a conventional bicycle with an electric drive added to assist the rider. The motor function is actuated by pedalling, which is scanned by a special sensor installed in the pedal hub. Therefore, you have to keep pedalling on an e-bike, the motor is there only to help you. You can set an electric bicycle in motion also using a control button or an accelerator but only up to the maximum permitted speed of 6 KMPH (e.g. for walk assistance). The maximum speed of an e-bike with motor assistance is 25 KMPH, with a 10% tolerance (when this speed limit is reached, the motor switches off and you need to pedal just like with a regular bicycle). When your battery runs out of power or your motor is off, you can ride your electric bicycle as a conventional bike, without any resistance at all.

From the point of view of the Road Traffic Act, an electric bicycle whose features conform to European standard EN 15194-1 is regarded as a regular bicycle, i.e. you can ride on bike trails, do not need a driver's license and a helmet is mandatory only up to 18 years of age.

Description



Factors influencing the electric bicycle range

- 1. Rolling resistance of the tyres.** Leader Fox e-bikes are fitted with tyres with low rolling resistance and increased resistance to puncture. It is also important that the tyres are inflated properly. Therefore, if the tyres of your electric bicycle are underinflated, the range will decrease.
- 2. Weight of the electric bicycle.** The lower weight of the electric bicycle, the greater the range.
- 3. Battery status.** It depends on whether the battery was fully charged before your trip. It is also to be expected that the higher the number of discharge cycles the battery has undergone, the smaller capacity it has.
- 4. Profile and surface of the track.** The higher the elevation difference and the steeper hills you negotiate and the worse surface, the shorter the range.
- 5. Riding mode.** It depends on which of the three riding modes you have set.
- 6. Continuity of riding.** The more braking and acceleration, the shorter the range.
- 7. Air resistance.** For example, it depends on whether we ride a bicycle with low frame and sitting upright or whether we ride sporty bicycle with seat set to the same height as the handlebars.
- 8. Wind strength.** The stronger the wind we have back, the longer the range and vice versa.
- 9. Weight of the rider and load.** The greater the weight, the shorter the range.
- 10. External temperature.** The lower the temperature, the less battery capacity can be used while riding.

Electric set

M420

The system uses monitoring of torque, monitoring of speed of the pedal assist system and monitoring of real speed of wheels.

The system uses a dual protection feedback for measuring the speed signal to ensure safety and reliability of the system.

It has high starting torque, maximum torque of over 80 Nm, suitable especially for riding uphill.

It is highly efficient with low power consumption, long range, low noise levels, and smooth operation.

Description and scope of operation:

The motor unit works properly under the following operating conditions:

Temperature range - 20 + 45°C

Relative humidity - 15 – 95% RH

Maximum torque - ≥ 80

Weight - 3.6Kg

Noise - <55 dB

Dustproof/ waterproof -IP66

Certified -CE ROHS/ EN14766/ EN114764/ REACH

Front and rear light -DC 400mA/6V

Description of the power unit is placed on the cover and shows the following information:

MM G332.250 – -name of motor unit

1401 -date of manufacture e.g.: January 2014 in this case

0001 -is so-called serial number which ranges between 0000 and 9999, 0001 is for example the serial number

of the first manufactured motor.

36V -nominal voltage

250W -nominal motor power

Dimensions of the power unit:

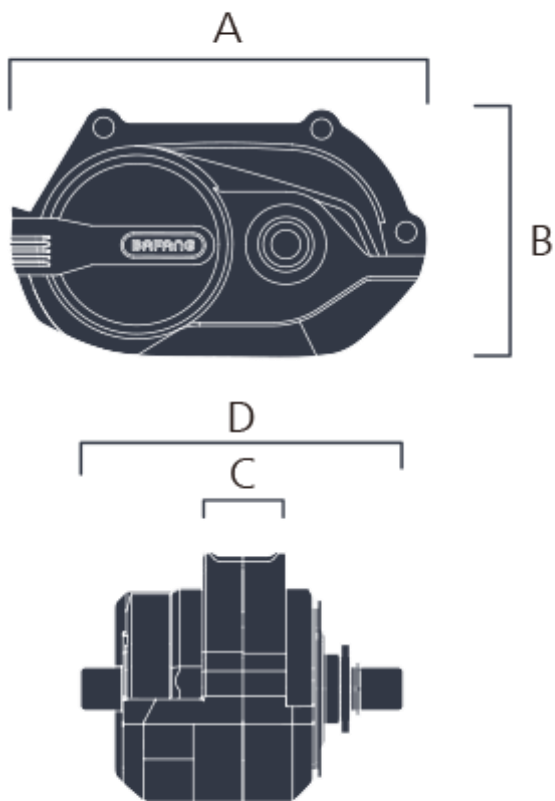

Dimension A	202 mm
Dimension B	123 mm
Dimension C	41.5 mm
Dimension D	154.8 mm

Safety instruction

Battery:

- Do not throw the battery into fire.
- Do not throw the battery into water.
- Do not use the battery for other appliances. It has been made specifically for this model.
- Do not dismantle or modify the battery.
- Do not connect the positive and negative poles of the battery.

Charger:

- Do not dismantle or modify the charger.
- Do not use the charger for other appliances. It has been made specifically for this model.
- Do not throw the charger into fire or water.
- Do not touch the charger with wet hands.
- Keep the charger from animals or children.
- Do not cover the charger.
- Do not use the charger if it is broken.

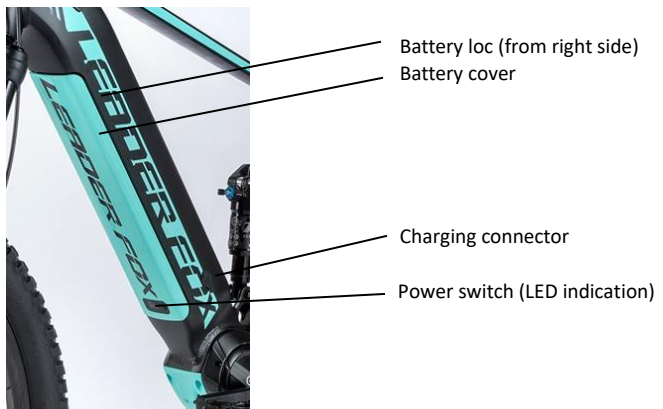

Charging set



Battery

Battery charging and maintenance:

Charge the battery in a dry environment to avoid short-circuit damage.

Charge the battery to at least 60% of the capacity once every 3 months even when the bicycle is not used.

Do not cover the battery or the charger.

Do not leave the battery constantly connected to the power source.

Do not use the battery for other appliances. It has been made specifically for this model.

Do not disassemble or modify the battery pack.

Do not throw the battery into fire or expose it to extreme temperatures.

Recharging time from zero to 100% is 1-7 hours.

Drive warranty:

The warranty applies to those drive parts that are not sensitive to improper handling (pack, electronics, charger, etc.); such parts are covered by a 24-month warranty.

The warranty does not apply to chemical parts of the battery and to capacity reduction due to normal use (39% after the expiry of two years); those parts are covered by a 12-month warranty.

Charging:

The battery is the most expensive part of an electric bicycle; therefore, pay increased attention during handling, charging and storage. The battery is sensitive to precise charging. Therefore, it is necessary to charge Li-Ion rechargeable batteries using only a charger supplied by us. Connect the charger to 220-240 V power outlet. 5A protected circuit is sufficient. The charger will automatically suspend charging when full capacity of all cells is reached.

We recommend discharging the battery in full after each ride to ensure that your battery will be up to its full capacity for your next ride. Charging the battery may last 1 to 5 hours depending on the condition of the battery cells. Charge it exclusively in covered dry areas (moisture and dripping water can damage the charger) at a temperature of 5 to 40°C.

The charging process is indicated by a red glowing LED. It will turn green when the battery is charged and the charging process is complete. The battery contains a charge-monitoring indicator (when the charge indicator button is pressed, the light indicator will come on). Always switch off the battery when finished riding the bike.

Normal battery behaviour:

If the motor stops running smoothly and switches to intermittent operation, it could be a sign of low battery capacity. In that case switch off the electric drive system and continue without motor assistance, as if riding a conventional bicycle.

Battery warming is normal and does not indicate any defect. The battery is protected by a temperature sensor and switches off automatically in case of excessive overheating. Wait until the battery cools down to its normal operating temperature and then ride on.

If you feel your total battery capacity has dropped, it could be caused by charging or operation in suboptimal climatic conditions. Carry out 3 full charging cycles. Fully discharge the battery while riding and then charge to its full capacity at room temperature.

If the charge indicator shows that the battery is discharged, there is still a minimum voltage level in it which protects it against damage but is not enough to power the electric bicycle. Recharge the battery as soon as possible. Never leave the battery fully discharged, it could result in its damage.

In the case, that the battery will be turned on more than 30 min and bike will not be used, the battery will be automatically switched off.

Proper care of the battery prolongs its life.

LCD display

Product:

LCD display DP C221 .CAN BUS

Supplier:

Bafang

Electrical parameters:

Battery supply 36V

Rated operating current 10mA

Off leakage current < 1 uA

CAN BUS protocol

Maxoutput current 300mA

Operating temperature -- -20 ~ 45 °C

Storage temperature -- -20 ~ 50 °C

LCD description and materials:

Prodcut shell is ABS.

CE / IPX5 water proof / ROHS



LCD Display description:

Speed indication: Includes maximum speed, average speed.

Intelligent battery capacity indication.

Control and indication for the headlight.

5 levels of backlight brightness setting.

Indication for power assistance level 0-3

Indication for trip: To indicate single-trip distance, total distance and remaining distance.

Multiple data indication: Indication for the remaining distance, Indication for the consumption of energy

Record and indication for the error information.

Control and indication for push assistance.

Maximal range:

Maximal range is set with fully charge battery and flat terrain and little bit of headwind. Average range is calculated with ideal set of the assist and slightly hilly terrain.

Controller

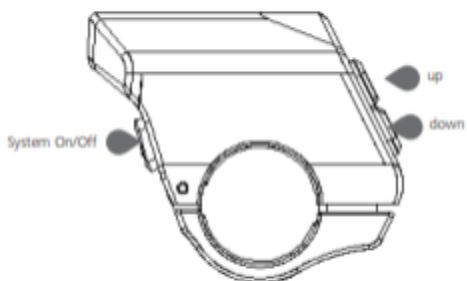
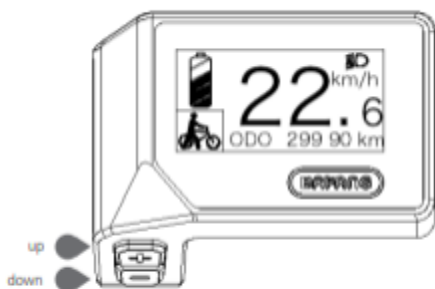

Assembly instructions

Display assembly:

1. Remove the holding bracket from the display, and then place the display into position on the handlebar. (suitable for $\varnothing 22.2$ mm handlebar).



2. Then place the holding bracket on the underside of the display and tighten it into position with a M3.0*8 screw. Torque requirement: 1.0 N.m.



3. Now connect the Display connector to the EB-Bus connector, ensuring both connectors are kept parallel when pushing firmly together.

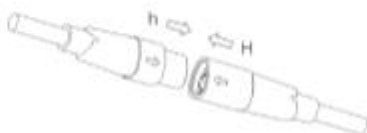

Control



7.7.1 Switching the System ON/OFF

Press and hold  (>2S) on the display to turn on the system. Press and hold  (>2S) again to turn off the system.

If the "automatic shutdown time" is set to 5 minutes (it can be reset with the "Auto Off" function, See "Auto Off"), the display will automatically be turned off within the desired time when it is not in operation. If the password function is enabled, you must enter the correct password to use the system.



7.7.2 Selection of Support Levels

When the display is turned on, press the  or  button (<0.5S) to switch to the support level, the lowest level is 0, the highest level is 3. When the system is switched on, the support level starts in level 1. There is no support at level 0.



7.7.3 Selection mode

Briefly press the  button (<0.5s) to see the different trip modes.

Trip: daily kilometers (TRIP) - total kilometers (ODO) - Maximum speed (MAX) - Average speed (AVG)
- Remaining distance (RANGE) - Energy consumption (CALORIES) - Output power (POWER) - Travel time (TIME).

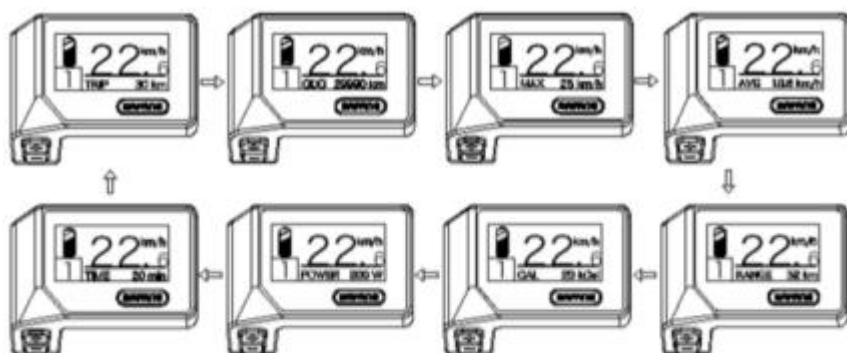

7.7.4 Headlights / backlighting





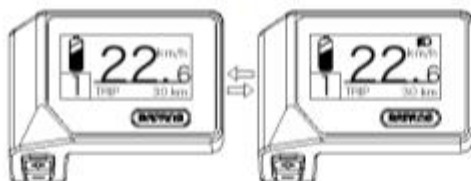

Hold the  button (>2S) to activate the headlight and taillights.

Hold the  button (>2S) again to turn off the headlight. The brightness of the backlight can be set in the display settings "Brightness".



7.7.5 Walk Assistance

The Walk assistance can only be activated with a standing pedelec.

Activation: Press the  button until this symbol  appears. Next press and hold down the  button whilst the  symbol is displayed, now the Walk assistance will activate. The symbol  will blink and the pedelec moves approx. 4.5 km/h. After releasing the  button or no button is pressed within 5S, the motor stops automatically and switches back to level 0.



7.7.6 SERVICE

The display shows "SERVICE" as soon as a certain number of kilometers or battery charges has been reached. With a mileage of more than 5000 km (or 100 charge cycles), the "SERVICE" function is displayed on the display. Every 5000 km the display "SERVICE" is displayed every time. This function can be set in the display settings.



7.7.7 Battery capacity indicator

The battery capacity is shown in the top left of the display. Each full bar represents a remaining capacity of the battery in a percentage.

(as shown in the diagram below):

Capacity Range	Indicator
80%-100%	
60%-80%	
40%-60%	
20%-40%	
5%-20%	
<5%	blinking

7.8 SETTINGS

After the display is turned on, press and hold the **▲** and **■** buttons (at the same time) to enter into the setting menu. By pressing the **▲** or **■** button (<0.5S), you can highlight and select Display Setting, Information or Exit. Then press the **■** button (<0.5S) to confirm your selected option.

Or highlight "EXIT" and press the **■** button (<0.5S) to return to the main menu, or highlight "BACK" and press (<0.5S) the **■** button (<0.5S) to return to the Settings interface.



7.8.1 "Display Setting"

Press the **▲** or **■** button (<0.5S) and highlight Display Setting, and then briefly press the **■** button (<0.5S) to access the following selections.

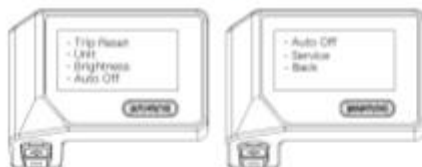

7.8.1.1 "TRIP Reset" Reset mileage

Press the **▲** or **■** button (<0.5S) to highlight "Trip Reset" in the Display setting menu, and then press **■** button (<0.5S) to select. Then with the **▲** or **■** button choose between "YES" or "NO". Once you have chosen your desired selection, press the **■** button (<0.5S) to save and exit to the "Display setting".

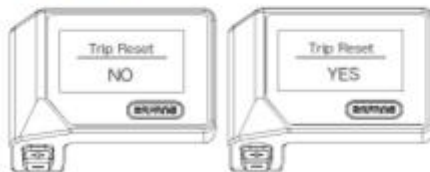

7.8.1.2 "Unit" Selections in km/Miles

Press the **+** or **-** button (<0.5S) to highlight "Unit" in the Display setting menu, and then press **OK** button (<0.5S) to select. Then with the **+** or **-** button choose between "Metric" (kilometer) or "Imperial" (Miles). Once you have chosen your desired selection, press the **OK** button (<0.5S) to save and exit to the "Display setting".

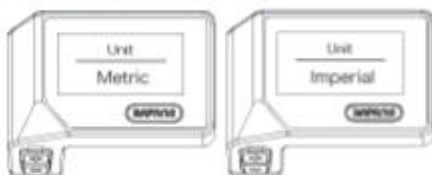

7.8.1.3 "Brightness" Display brightness

Press the **+** or **-** button (<0.5S) to highlight "Brightness" in the Display setting menu, and then press **OK** button (<0.5S) to select. Then with the **+** or **-** button choose between "100%" / "75%" / "50%" / "30%" / "10%". Once you have chosen your desired selection, press the **OK** button (<0.5S) to save and exit to the "Display setting".

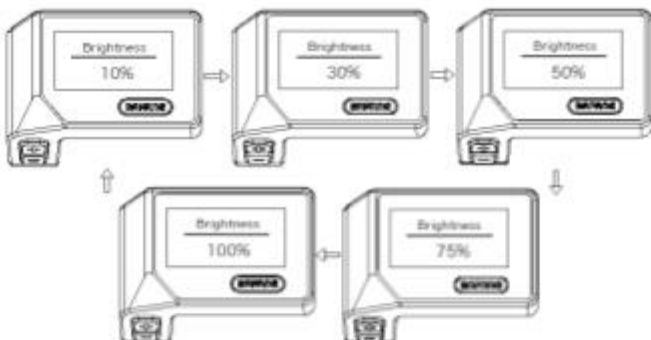

7.8.1.4 "Auto Off" Set Automatic system switch off time

Press the **+** or **-** button (<0.5S) to highlight "Auto Off" in the Display setting menu, and then press **OK** button (<0.5S) to select. Then with the **+** or **-** button choose between "OFF", "9"/"8"/"7"/"6"/"5"/"4"/"3"/"2"/"1", (The numbers are measured in minutes). Once you have chosen your desired selection, press the **OK** button (<0.5S) to save and exit to the "Display setting".



7.8.1.5 "Service" Switching the notification on and off

Press the **+** or **-** button (<0.5S) to highlight "Service" in the Display setting menu, and then press the **OK** button (<0.5S) to select. Then with the **+** or **-** button choose between "NO" or "YES". Once you have chosen your desired selection, press the **OK** button (<0.5S) to save and exit to the "Display setting".



7.8.2 "Information"

Once the display is turned on, press and hold the **+** and **-** buttons (at the same time) to enter into the setting menu, press the **+** or **-** button (<0.5S) to select "Information", then press the **OK** button (<0.5S) to confirm and enter into "Information".



7.8.2.1 Wheel Size

Press the **+** or **-** button (<0.5S) to highlight "Wheel Size", then press the **OK** button (<0.5S) to confirm and view the wheel size. To return, press the **OK** button (<0.5S) to exit back to the "Information".

This information cannot be changed, this is only for information, about the pedelec.



7.8.2.2 Speed Limit

Press the **+** or **-** button (<0.5S) to highlight "Speed Limit", then press the **OK** button (<0.5S) to confirm and view the speed limit. To return, press the **ESC** button (<0.5S) to exit back to the "Information".

This information cannot be changed, this is only for information, about the pedelec.



7.8.2.3 Battery Information

Press the **+** or **-** button (<0.5S) to highlight "Battery Info", then press the **OK** button (<0.5S) to confirm. Now press the **+** or **-** button (<0.5S) to view the contents.

To return, press the **ESC** button (<0.5S) to exit back to the "Information".



Code	Code definition	unit	Code	Code definition	unit
Hardware ver	Hardware version		b10	Absolute SOC	%
Software ver	Software version		b11	Cycle	times
b01	Current temperature	°C	b12	Maximum not charging time	Hour
b04	Total voltage	mV	b13	Recently not charging time	Hour
b06	Average current	mA	d00	Number of battery cell	
b07	Remaining capacity	mAh	d01	Voltage of cell 1	mV
b08	Full charge capacity	mAh	d02	Voltage of cell 2	mV
b09	Relative SOC	%	dn	Voltage of cell n	mV

NOTE: If no data is detected, "--" is displayed.

7.8.2.4 Controller Information

Press the **+** or **-** button (<0.5S) to highlight "Ctrl Info", then press the **OK** button (<0.5S) to confirm. Now press the **+** or **-** button (<0.5S) to view Hardware Version or Software Version.

To return, press the **ESC** button (<0.5S) to exit back to the "Information".



7.8.2.5 Display Information

Press the **+** or **-** button (<0.5S) to highlight "Display Info", then press the **OK** button (<0.5S) to confirm. Now press the **+** or **-** button (<0.5S) to view Hardware Version or Software Version.

To return, press the **ESC** button (<0.5S) to exit back to the "Information".



7.8.2.6 Torque Information

Press the **+** or **-** button (<0.5S) to highlight "Torque Info", then press the **OK** button (<0.5S) to confirm. Now press the **+** or **-** button (<0.5S) to view Hardware Version or Software Version.

To return, press the **ESC** button (<0.5S) to exit back to the "Information".



7.8.2.7 Error Code

Press the **+** or **-** button (<0.5S) to highlight "Error code", then press the **OK** button (<0.5S) to confirm. Now press the **+** or **-** button (<0.5S) to view a list of error codes from the pedelec. It can show information for the last ten errors of the pedelec. The error code "00" means that there is no error.

To return, press the **ESC** button (<0.5S) to exit back to the "Information".

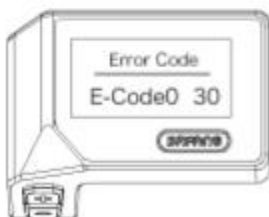

Basic setting:

System is factory set. For changing these parameters contact your dealer or producer.

Do not change these parameters by yourself, you can damage the e-bike.

Damaged caused by improper treatment is not within the scope of the warranty

Maintenance

Regular maintenance:

- maintain all components of the electric bicycle clean
- use only the recommended and tested cleaning materials
- regularly lubricate the chain with suitable oils
- in winter, clean the electric bicycle after each ride and pay increased attention to removing salt from battery contacts and other connectors
- while handling the electric bicycle, make sure the cables of the electric system are not damaged. Damaged cables pose a risk of electricshock
- regularly check all connections for correct tightening and brakes for correct function. Check also individual parts of the electric bicycle for damage. For example: cracks on the frame, fork, handlebars, stem, damage to cables, damage to battery pack, etc.

Battery transport:

Battery transport is subject to the requirements of regulations on dangerous goods. Private users may transport undamaged batteries on roads without having to conform to other conditions.

In case of transport by commercial users or by third parties it is necessary to comply with special packaging and marking requirements (e.g. ADR regulations)

Batteries should only be sent if the battery pack is undamaged. Plug loose contacts and pack the battery to prevent its movement in the packaging. Notify the forwarding service that the transport concerns dangerous goods.

Battery storage:

Store the battery in a dry and well-ventilated place, out of reach of direct sunlight and other heat sources. In case of cold storage it is necessary to let the battery warm up to normal room temperature (20°C) before putting into operation.

Never leave the battery fully discharged. It could result in its permanent damage. For long-term storage keep the battery fully charged. However, do not store it while permanently connected to the charger or installed in the electric bicycle.

Li-Ion batteries are fully recyclable. After expiry of the battery life you can return it at any collection point or your dealer.

If you use an e-bike in hard conditions (long-term use of the maximum assistance), for longer ride at higher temperatures (30 ° C or above), in direct sunlight or when the battery is partially discharged and a combination of these situations is it possible that bike will automatically switch off. This is a fuse protecting the control unit against burning. We recommend stop the ride and let the bike (control unit) cool down little bit. This is not a defect.

Possible problems and their solutions

In case of system failure perform its diagnostics or contact your dealer.

The control LCD display is not on:

- always make sure the battery is charged
- check whether the battery is inserted correctly, whether the battery switch is on
- check the connections of the control unit and the display

The motor does not start when the walk assistance button is pressed

- check the connection of the motor cable (at the motor and the control unit)
- check the connections of the control unit and the display

The motor does not start when rotating the pedal cranks (pedalling)

- check the connection of the pedalling sensor to the control unit
- check the distance between the pedalling sensor and the magnet disk (max. 4 mm)
- check whether the disk is firmly attached to the central axle and does not spin freely
- in case of use of compact-type pedalling sensor

Warning

Note: Please read carefully the description of the error code. When the error code appears, please first restart the system. If the problem is not eliminated, please contact your dealer or technical personnel.

Error	Declaration	Troubleshooting
04	The throttle has fault.	<ol style="list-style-type: none">1. Check the connector and cable of the throttle are not damaged and correctly connected.2. Disconnect and reconnect the throttle, if still no function please change the throttle.
05	The throttle is not back in its correct position.	Check the connector from the throttle is correctly connected. If this does not solve the problem, please change the throttle.
07	Overvoltage protection	<ol style="list-style-type: none">1. Remove and re-Insert the battery to see if it resolves the problem.2. Using the BESST tool update the controller.3. Change the battery to resolve the problem.
08	Error with the hall sensor signal inside the motor	<ol style="list-style-type: none">1. Check all connectors from the motor are correctly connected.2. If the problem still occurs, please change the motor.
09	Error with the Engine phase's	Please change the motor.
10	The temperature inside the engine has reached its maximum protection value	<ol style="list-style-type: none">1. Turn off the system and allow the Pedelec to cool down.2. If the problem still occurs, please change the motor.
11	The temperature sensor inside the motor has an error	Please change the motor.
12	Error with the current sensor in the controller	Please change the controller or contact your supplier.

Error	Declaration	Troubleshooting
13	Error with the temperature sensor inside of the battery	<ol style="list-style-type: none"> 1. Check all connectors from the battery are correctly connected to the motor. 2. If the problem still occurs, please change the Battery.
14	The protection temperature inside the controller has reached its maximum protection value	<ol style="list-style-type: none"> 1. Allow the pedelec to cool down and restart the system. 2. If the problem still occurs, please change the controller or contact your supplier.
15	Error with the temperature sensor inside the controller	<ol style="list-style-type: none"> 1. Allow the pedelec to cool down and restart the system. 2. If the problem still occurs, Please change the controller or contact your supplier.
21	Speed sensor Error	<ol style="list-style-type: none"> 1. Restart the system 2. Check that the magnet attached to the spoke is aligned with the speed sensor and that the distance is between 10 mm and 20 mm. 3. Check that the speed sensor connector is connected correctly. 4. Connect the pedelec to BESST, to see if there is a signal from the speed sensor. 5. Using the BESST Tool- update the controller to see if it resolves the problem. 6. Change the speed sensor to see if this eliminates the problem. If the problem still occurs, please change the controller or contact your supplier.
25	Torque signal Error	<ol style="list-style-type: none"> 1. Check that all connections are connected correctly. 2. Please connect the pedelec to the BESST system to see if torque can be read by the BESST tool. 3. Using the BESST Tool update the controller to see if it resolves the problem, if not please change the torque sensor or contact your supplier.

Error	Declaration	Troubleshooting
26	Speed signal of the torque sensor has an error	<ol style="list-style-type: none"> 1. Check that all connections are connected correctly. 2. Please connect the pedecec to the BESST system to see if speed signal can be read by the BESST tool. 3. Change the Display to see if the problem is solved. 4. Using the BESST Tool update the controller to see if it resolves the problem, if not please change the torque sensor or contact your supplier.
27	Overcurrent from controller	Using the BESST tool update the controller. If the problem still occurs, please change the controller or contact your supplier.
30	Communication problem	<ol style="list-style-type: none"> 1. Check all connections on the pedecec are correctly connected. 2. Using the BESST Tool run a diagnostics test, to see if it can pinpoint the problem. 3. Change the display to see if the problem is solved. 4. Change the EB-BUS cable to see if it resolves the problem. 5. Using the BESST tool, re-update the controller software. If the problem still occurs please change the controller or contact your supplier.
33	Brake signal has an error (If brake sensors are fitted)	<ol style="list-style-type: none"> 1. Check all connectors are correctly connected on the brakes. 2. Change the brakes to see if the problem is solved. <p>If problem continues Please change the controller or contact your supplier.</p>
35	Detection circuit for 15V has an error	Using the BESST tool update the controller to see if this resolves the problem. If not, please change the controller or contact your supplier.
36	Detection circuit on the keypad has an error	Using the BESST tool update the controller to see if this resolves the problem. If not, please change the controller or contact your supplier.

Error	Declaration	Troubleshooting
37	WDT circuit is faulty	Using the BESST tool update the controller to see if this resolves the problem. If not, please change the controller or contact your supplier.
41	Total voltage from the battery is too high	Please change the battery.
42	Total voltage from the battery is too low	Please Charge the battery. If the problem still occurs, please change the battery.
43	Total power from the battery cells is too high	Please change the battery.
44	Voltage of the single cell is too high	Please change the battery.
45	Temperature from the battery is too high	Please let the pedelec cool down. If problem still occurs, please change the battery.
46	The temperature of the battery is too low	Please bring the battery to room temperature. If the problem still occurs, please change the battery.
47	SOC of the battery is too high	Please change the battery.
48	SOC of the battery is too low	Please change the battery.
61	Switching detection defect	1. Check the gear shifter is not jammed. 2. Please change the gear shifter.
62	Electronic derailleur cannot release.	Please change the derailleur.
71	Electronic lock is jammed	1. Using the BESST tool update the Display to see if it resolves the problem. 2. Change the display if the problem still occurs, please change the electronic lock.
81	Bluetooth module has an error	Using the BESST tool, re-update the software onto the display to see if it resolves the problem. If not, Please change the display.

7.10 WARNING CODE DEFINITION

Warning	Declaration	Troubleshooting
28	Torque sensor w-code 0	Restart the system and please not to step on the crank hard when restarting.

Electric set warranty

Complaint procedure:

Submit any complaints concerning the electric set or the battery to your dealer.

When filing a complaint, submit a proof of purchase and a warranty certificate with the registered serial number of the battery and indicate the reason for the complaint and a description of the defect.

Warranty conditions:

24 months for electric bicycle components – applies to manufacturing and material defects beyond normal wear and tear caused by use.

12 months for battery life – the nominal battery capacity does not drop below 70% of the total capacity over 12 months from the sale of the electric bicycle.

Warranty conditions:

The electric set must be used exclusively for the purposes it is intended for.

The electric set must be used, stored and maintained in accordance with these Operating Instructions.

A warranty claim shall expire:

If it is found out that the damage to the product is due to the user's fault (accident, inexpert handling beyond the framework of these Operating Instructions, tampering with the structure of the electric bicycle or connection of the electric system, improper storage, etc.).

Expiry of the warranty period.

The warranty only applies to the first owner

Warning

If you do not understand any of the points in these Operating Instructions, please contact the dealer for explanation. Please read the whole manual!

Do not lend the e-bike to persons not briefed in its use and operation. Complaints resulting from improper handling will not be accepted.

The LF Energy electric bicycle is not intended for use by children under 15 years of age. Likewise, the electric bicycle cannot be used by persons unable to pedal or handle it independently. The manufacturer is not to be held responsible for any potential injuries or damage to the bicycle!

Ideal weather conditions for using an electric bicycle are dry days, when the outdoor temperature is above 10°C. When used at lower temperatures, the battery discharges faster due to physical phenomena. Using the electric bicycle at temperatures below 0°C is not recommended.

Do not expose the bicycle to direct sunlight as it is fitted with a protective temperature sensor for the electric motor.

Never submerge the battery, the charger and other electric components in water or another liquid.

Never wash the electric bicycle in a pressure washer (WAP) and always remove the battery before washing

It is forbidden to tamper with the connections of the electric motor, the control unit and the battery. Violating this section may result in the warranty not being acknowledged or in irreversible damage to the electric bicycle.

DO NOT USE chargers and components other than the ones included with the electric bicycle.

We cannot be held responsible for damage caused by use of other non-approved goods

bohemia**bike**

b i k e f a c t o r y

Na Pankráci 1724, 140 00 Praha 4 - Pankrác, IČ: 63910756

EU PROHLÁŠENÍ O SHODĚ

Prohlašujeme, že elektrokola značky Leader fox, dodávané na český i zahraniční trh společností Bohemia bike a.s. jsou v souladu s platnými českými technickými normami ČSN EN ISO 4210-2 i ustanovením evropských směrnic EN 15194:2017, 2006/42/EC A 2014/30/EU pro jízdní kola s pomocným elektrickým motorem tzv. EPAC. Výrobky jsou v souladu se směrnicí na strojní zařízení 2006/42/ES (NV 176/2008 Sb.) Tato vyrobená strojní zařízení splňují všechna příslušná ustanovení předmětného předpisu EU.

Seznam výrobků obsahuje příloha dokumentu:

V Českých Budějovicích 1. ledna 2020

bohemia bike a.s.

IČ: 63910756, DIČ: CZ63910756
Na Pankráci 1724, 140 00 Praha 4 - Pankrác
CZECH REPUBLIC (8)

.....
Pavel Müller, předseda představenstva a odpovědná osoba za veškerou tech. dokumentaci

LEADER FOX



Enjoy many pleasant and safe kilometres on your new electric bicycle.

Your Leader Fox Team



**Czech brand of electric bicycles.
BOHEMIA BIKE**

Address

Pujmanové 1753/10 a
140 00 Praha 4 – Nusle

Development, design and manufacturing

Okružní 697
České Budějovice 37001

Phone: 388 314 885
Email: info@leaderfox.cz

