

LEADER FOX



Electric Bicycle Operating Instructions

Under the law, the dealer is obliged to attach the LEADER FOX Electric Bicycle Operating Instructions to every product



E – BIKE POWER RIDE

Ayra
Arran
Orem
Orton



Introduction

Dear users,

Please read carefully all the information regarding your E-LF product to ensure optimal functioning of your e-bike. The following text containing a comprehensive description will provide you with information on all aspects and details (including installation, setting up and general use of the display) regarding the use of our display. This instruction document will also help you solve potential problems and failures.

What is an electric bicycle?

Electric bicycle is a conventional bicycle with an electric drive added to assist the rider. The motor function is actuated by pedalling, which is scanned by a special sensor installed in the pedal hub. Therefore, you have to keep pedalling on an e-bike, the motor is there only to help you. You can set an electric bicycle in motion also using a control button or an accelerator but only up to the maximum permitted speed of 6 KMPH (e.g. for walk assistance). The maximum speed of an e-bike with motor assistance is 25 KMPH, with a 10% tolerance (when this speed limit is reached, the motor switches off and you need to pedal just like with a regular bicycle). When your battery runs out of power or your motor is off, you can ride your electric bicycle as a conventional bike, without any resistance at all.

From the point of view of the Road Traffic Act, an electric bicycle whose features conform to European standard EN 15194-1 is regarded as a regular bicycle, i.e. you can ride on bike trails, do not need a driver's license and a helmet is mandatory only up to 18 years of age.

Description



Factors influencing the electric bicycle range

- 1. Rolling resistance of the tyres.** Leader Fox e-bikes are fitted with tyres with low rolling resistance and increased resistance to puncture. It is also important that the tyres are inflated properly. Therefore, if the tyres of your electric bicycle are underinflated, the range will decrease.
- 2. Weight of the electric bicycle.** The lower weight of the electric bicycle, the greater the range.
- 3. Battery status.** It depends on whether the battery was fully charged before your trip. It is also to be expected that the higher the number of discharge cycles the battery has undergone, the smaller capacity it has.
- 4. Profile and surface of the track.** The higher the elevation difference and the steeper hills you negotiate and the worse surface, the shorter the range.
- 5. Riding mode.** It depends on which of the three riding modes you have set.
- 6. Continuity of riding.** The more braking and acceleration, the shorter the range.
- 7. Air resistance.** For example, it depends on whether we ride a bicycle with low frame and sitting upright or whether we ride sporty bicycle with seat set to the same height as the handlebars.
- 8. Wind strength.** The stronger the wind we have back, the longer the range and vice versa.
- 9. Weight of the rider and load.** The greater the weight, the shorter the range.
- 10. External temperature.** The lower the temperature, the less battery capacity can be used while riding.

Electric set

GX Ultimate

The system uses monitoring of torque, monitoring of speed of the pedal assist system and monitoring of real speed of wheels.

The system uses a dual protection feedback for measuring the speed signal to ensure safety and reliability of the system.

It has high starting torque, maximum torque of over 90 Nm, suitable especially for riding uphill.

It is highly efficient with low power consumption, long range, low noise levels, and smooth operation.

Description and scope of operation:

The motor unit works properly under the following operating conditions:

Temperature range - 20 to + 40 °C

Maximum torque 90 Nm

Weight – 2.9 Kg

Dustproof/ waterproof-IP65

Certified-CE ROHS/ EN15194:2017

Description of the power unit is placed on the cover and shows the following information:

NUA213F – Engine model

E – assist for full suspension bikes

F – assist for hardtail bikes

29X18 – Date of manufacture, indicating it is manufactured on October 29, 2018

0001 – Production serial number

DC36V – Rated Voltage

250 W – Rated engine power

120rpm – Rated engine rotation speed

25 km/h – Max speed

Dimensions of the power unit:

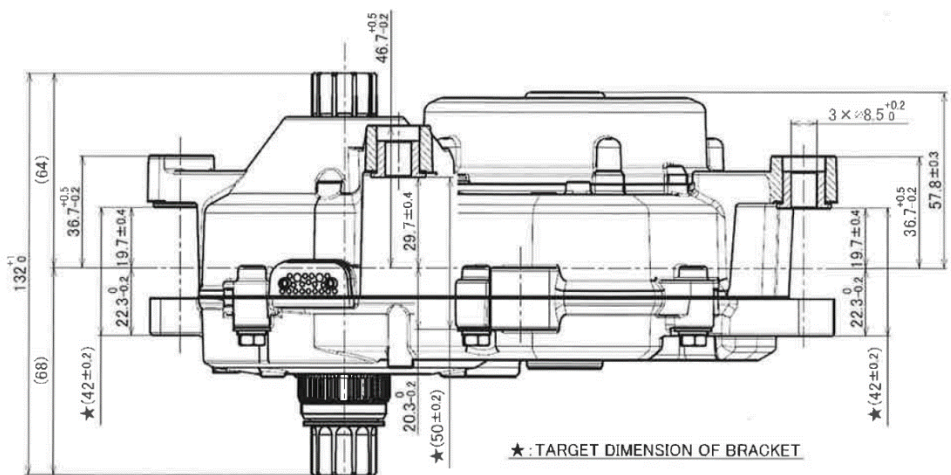
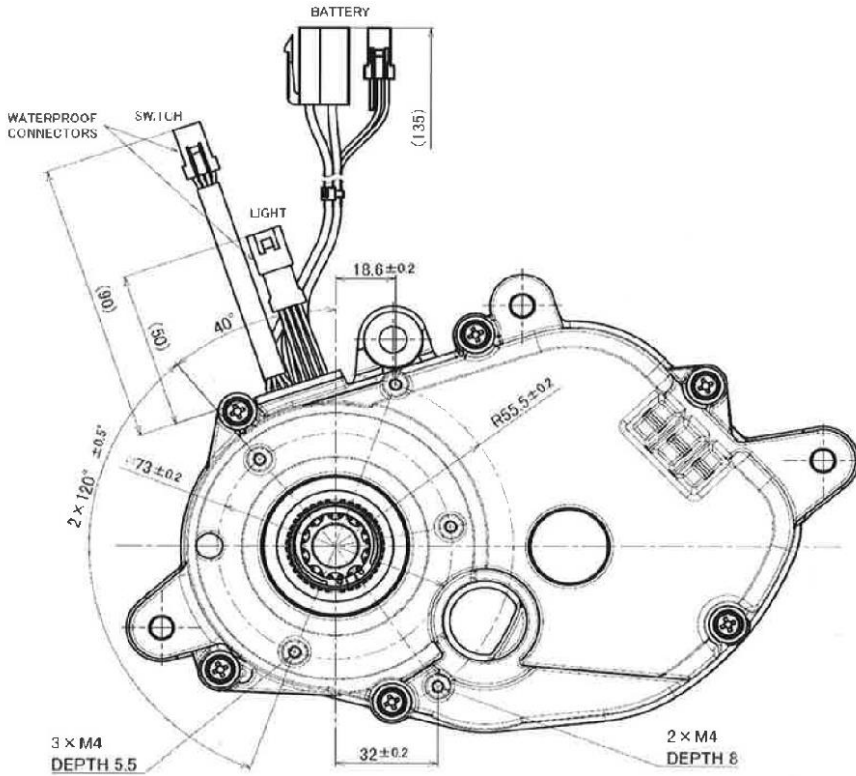

Safety instruction

Motor:

Waterproof IPX5, do not expose to high-pressure, heavy sprays of water.

Do not submerge the motor in water.

In the case of motor submersion in water, switch the unit off and stop using it.

Do not put the motor near magnetic field, it can tamper with sensors setting.

Battery:

Waterproof IPX5, do not expose to high-pressure, heavy sprays of water.

Do not submerge the battery into water.

Do not expose the battery to fire.

Do not use the battery for other appliances. It has been made specifically for this model.

Do not dismantle or modify the battery.

Do not connect the positive and negative poles of the battery.

Charger:

Do not dismantle or modify the charger.

Do not use the charger for other appliances. It has been made specifically for this model.

Do not throw the charger into fire or water.

Do not touch the charger with wet hands.

Keep the charger from animals or children.

Do not cover the charger.

Do not use the charger if it is broken

Battery



Switch and LED indication

Charging set



Battery

Battery charging and maintenance:

Charge the battery in a dry environment to avoid short-circuit damage.

Charge the battery to at least 60% of the capacity once every 3 months even when the bicycle is not used.

Do not cover the battery or the charger.

Do not leave the battery constantly connected to the power source.

Do not use the battery for other appliances. It has been made specifically for this model.

Do not disassemble or modify the battery pack.

Do not throw the battery into fire or expose it to extreme temperatures.

Recharging time from zero to 100% is 1-7 hours.

Drive warranty:

The warranty applies to those drive parts that are not sensitive to improper handling (pack, electronics, charger, etc.); such parts are covered by a 24-month warranty.

The warranty does not apply to chemical parts of the battery and to capacity reduction due to normal use (39% after the expiry of two years); those parts are covered by a 12-month warranty.

Charging:

The battery is the most expensive part of an electric bicycle; therefore, pay increased attention during handling, charging and storage. The battery is sensitive to precise charging. Therefore, it is necessary to charge Li-Ion rechargeable batteries using only a charger supplied by us. Connect the charger to 220-240 V power outlet. 5A protected circuit is sufficient. The charger will automatically suspend charging when full capacity of all cells is reached.

We recommend discharging the battery in full after each ride to ensure that your battery will be up to its full capacity for your next ride. Charging the battery may last 1 to 5 hours depending on the condition of the battery cells. Charge it exclusively in covered dry areas (moisture and dripping water can damage the charger) at a temperature of 5 to 40°C.

The charging process is indicated by a red glowing LED. It will turn green when the battery is charged and the charging process is complete. The battery contains a charge-monitoring indicator (when the charge indicator button is pressed, the light indicator will come on).

Normal battery behaviour:

If the motor stops running smoothly and switches to intermittent operation, it could be a sign of low battery capacity. In that case switch off the electric drive system and continue without motor assistance, as if riding a conventional bicycle.

Battery warming is normal and does not indicate any defect. The battery is protected by a temperature sensor and switches off automatically in case of excessive overheating. Wait until the battery cools down to its normal operating temperature and then ride on.

If you feel your total battery capacity has dropped, it could be caused by charging or operation in suboptimal climatic conditions. Carry out 3 full charging cycles. Fully discharge the battery while riding and then charge to its full capacity at room temperature.

If the charge indicator shows that the battery is discharged, there is still a minimum voltage level in it which protects it against damage but is not enough to power the electric bicycle. Recharge the battery as soon as possible. Never leave the battery fully discharged, it could result in its damage.

In the case, that the battery will be turned on more than 30 min and bike will not be used, the battery will be automatically switched off.

Battery is fully shutdown after 48h. After that time period you have to first activate the battery by switch button or connect battery with charger.

Proper care of the battery prolongs its life.

LCD display

Product:

Central display Panasonic

Supplier:

Panasonic

Parameters:

Black and white display

Protocol UART

USB port 5V DC, max. 1 A

Operating temperature – 10 ~ 40 °C

Storage temperature – 20 ~ 50 °C

CE / IP65 water and dust proof / ROHS.

Display description

The console comprises a display unit and operation unit.

Operation unit

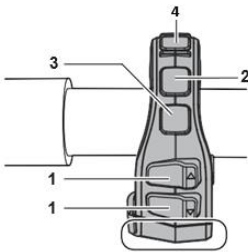

In case of X0: GX Ultimate/GX Power driving unit, this area is covered by plastic cover.



Display unit

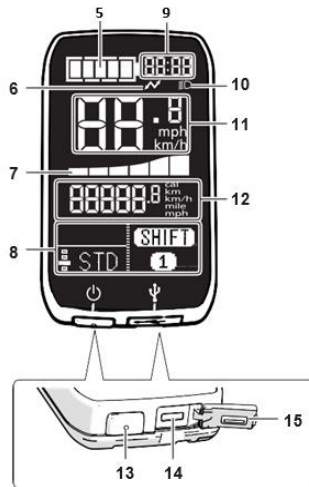

Backside

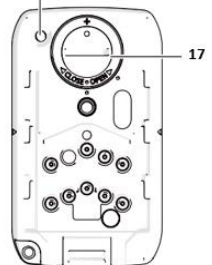

1 Assist mode select buttons

Selects the assist mode from [HIGH], [STANDARD], [ECO],[NO ASSIST] and [AUTO].

* If [AUTO] mode is not installed, [AUTO] is not indicated on the display unit.

2 Night mode button

* Lights the backlight of the display unit.

When power is supplied to the head light or tail lamp from the battery on the electric bicycle, the head lamp or tail lamp lights. It depends on local regulation.

3 [information] button

Switches display items such as distance travelled.

4 Bicycle mark button (Walk assistance)

Drive can be assisted up to 6 km/h when pushing the electric bicycle with a heavy load on it.

5 Battery level display

Displays the battery remaining capacity.

6 USB connection mark

Displayed when an external device (e.g. mobile phone) is connected to the display unit for charging.

7 Assist power indicator

Displays in the form of a graph how much the rider is being assisted. The larger the number on the graph, the more the rider is being assisted.

8 Text indication

Displays the current assist mode, etc.

9 Time display

Displays the current time.

10 Night mode indicator

Lights when the night mode button is pressed.

11 Speed indication

Displays the current travel speed.

12 Value indication

Displays distance travelled, total distance travelled, maximum speed, etc.

13 Power button

Turns on and off the electric bicycle system.

14 Micro USB port

Used to charge an external device (e.g. mobile phone).

15 Rubber cap

Protects the Micro USB port.

16 Reset button

Used to set the total distance travelled to "0".

17 Coin-type battery compartment

A coin-type battery is housed here for the time display of the display unit.

Display Battery

Using the display unit for the first time

The display unit has a built-in coin-type battery (3 V) to maintain time display memory. Before the display unit is shipped, the battery compartment contains a plastic plate to prevent the coin-type battery from discharging. Before using the display unit for the first time after purchase, remove the plastic plate by the following procedure.

Coin-type battery compartment

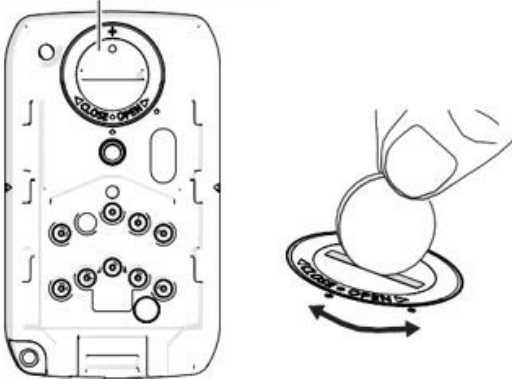

- 1) Turn the lock cover on the coin-type battery compartment on the backside of the display unit counterclockwise with a coin, etc.**
 - The coin-type battery compartment opens.
- 2) Remove the coin-type battery and pull out the plastic plate on the minus side.**
 - After removing the plastic plate, dispose of it appropriately.
- 3) Insert the coin-type battery into the coin-type battery compartment, then turn the lock cover clockwise to lock the coin-type battery compartment.**
- 4) Set the time.**

Attention

- If the lock cover is not firmly locked, the display unit may not operate properly due to malfunctions such as water seeping in.

Note

- When the time display "0:00" is blinking, this indicates that the coin-type battery has reached the end of its service life. The procedure for replacing the coin-type battery (part No.: CR2032X1) is the same as the steps 1) to 4).
- When the coin-type battery has reached the end of its service life, only clock functions stop. Since liquid leakage may cause a malfunction, immediately replace the coin-type battery that are no longer usable with a new one. Dispose of coin-type batteries that are no longer usable in accordance with the regional recycle laws.

Assembly instructions

Display assembly:

Mount the display unit on the cradle with the cradle mounted on the handlebar of the electric bicycle and a fully charged battery mounted on the electric bicycle.

Note: Before mounting the display unit, wipe the contact surface on the top of the cradle or the contact surface on the rear of the display unit with a soft, dry cloth if it is wet or dirty.

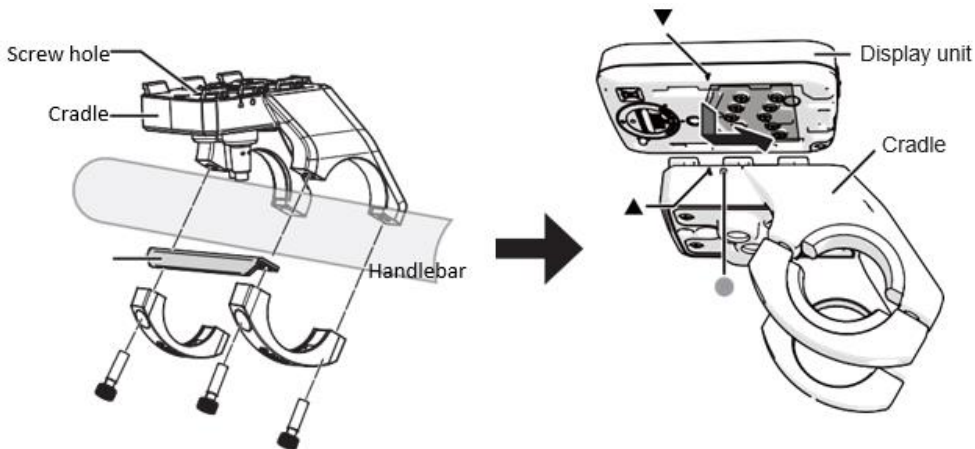

Fixing the display unit in place. If the display unit is not to be removed, it can be fixed in place on the cradle with M4 x L10 screw.

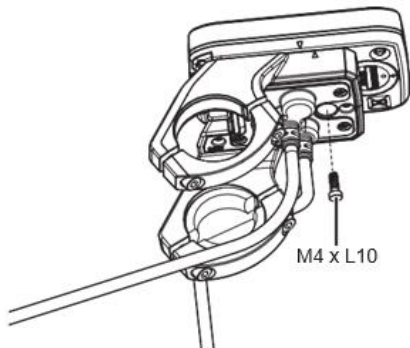

Please pay attention to the tightening torque of screws. Damage caused by excessive tightening torque or incorrect assembly / disassembly is not covered by warranty.

Removing the display unit of the console

Remove the display unit from the cradle after turning the electric bicycle system off.

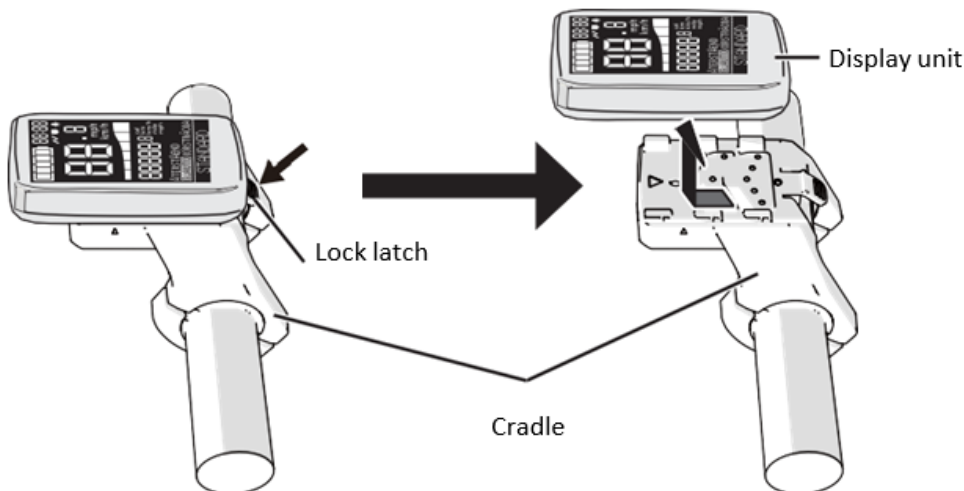

1) Press the power button on the display unit to turn off the electric bicycle system.

- If the electric bicycle system is already turned off, proceed to step 2).
- When the display unit is fixed in place on the cradle using the setscrew, confirm that the setscrew is removed, and proceed to step 2).

2) Slide the display unit in the direction of the arrow in the illustration with the lock latch on the cradle pressed down to remove the display unit.

Note

- If the display unit is removed with the electric bicycle system still turned on, the screen display goes out, and the assist function also stops after about three seconds.
- Do not remove the display unit while you are riding.
- When mounting the removed display unit on the cradle again to use it, confirm that the display unit operates properly.

Control

Turning on the electrical system of the e-bike:

Press the power button on the display unit. Battery level indication lamps, etc. light. When you start pedaling, the assist function starts to work.

Attention

- Before pressing the power button, do not place your feet on the pedals of the electric bicycle. Otherwise, this will result in a torque sensor error or less of an assisted sensation. Press the power button again without placing your feet on the pedals.
- While pressing the power button, do not press any other buttons, otherwise an error may be displayed. In this case press the power button again without your feet on the pedals.
- When the battery is being charged while still mounted on the electric bicycle, the system will not turn on. Accordingly, the motor unit will not start.
- Do not turn on/off the power button during riding. If the assist function is not required, press the assist mode select buttons to select [NO ASSIST].

Note

- The assist function of the electric bicycle will not work in the following cases:
 - When you stop pedaling
 - When a speed of 25 km/h is reached (The assist function starts to work again by pedaling at 25 km/h or less.)
 - When there is no remaining battery power

Turning off the electric bicycle system:

Press the power button on the console when the electric bicycle system is turned on.

Note

- Even if the power button is not pressed to turn off the electric bicycle system, the power automatically turns off to save energy if the electric bicycle is not used for about ten minutes (for example, when the electric bicycle is parked).

Assist modes:

Use the buttons on the operation unit to change the assist mode.
Five assist modes can be selected by pressing the assist mode select buttons.

Item	Description
[NO ASSIST]	No assist force. The display shows all relevant data.
[ECO]	A low assist force is provided allowing for a longer distance traveled by a single charge. Effective assist for long range riding.
[STANDARD]	A mid assist force is provided. Default assist for any terrain.
[AUTO]	The assist force automatically changes from low to powerful. Optimal motor assist depending on the rider's input torque.
[HIGH]	Maximum motor assist. A powerful assist force is provided for a comfortable ride on slopes and carrying heavy loads

Walking assistance

This is the push-assistance function that assists you by providing drive up to 6 km/h, for example, when you are carrying a heavy load or pushing the bike uphill.







Hold down the bicycle mark button (Walk assistance). When you release your finger from the bicycle mark button (Walk assistance), or the electric bicycle exceeds a speed of 6 km/h, the function will not be activated.

Walk assistance speed depends on gear ratio. Lower gear ratio / slower speed, higher gear ratio/ faster speed.

Battery level display

The battery charge status indicates the remaining capacity of the battery in the electric bicycle (not the status of coin-type battery inside the display unit).

The charged state of the battery on the electric bicycle can also be checked by the battery LED.

Battery level display						
	5 lit	4 lit	3 lit	2 lit	1 lit	1 blinking* ¹
Remaining capacity of the battery in the electric bicycle	81% to 100%	61% to 80%	41% to 60%	21% to 40%	11% to 20%	1% to 10%

*¹ The display changes as follows when there is no longer any remaining battery power.

Trip, Average, Max. Speed, Range, Battery capacity

For the distance display and battery level, items and numerical values are displayed at Text indication and Value indication, respectively. Items can be switched.

Item	Description
[TRIP]	Displays the distance travelled.
[AVG]	Displays the average speed.
[MAX]	Displays the maximum speed during travel so far.
[ODO]	Displays the total distance travelled. The total distance travelled is set to "0" by holding down the reset button on the rear of the display unit and the [information] button on the operation unit at the same time. (Fig. 2 and3)
[RANGE]	Displays how far the electric bicycle can travel (estimated distance) on the remaining battery power under fixed conditions (e.g. assist mode, route profile).*1
Remaining battery capacity	Displays the battery level.

*1 This is a rough value because the remaining battery capacity is calculated using the amount consumed.

Press the [information] button on the operation unit.

- Each press of the button switches the item.

Note

- The values for [TRIP], [AVG] and [MAX] are reset together.
- To reset, press the [information] button, display [TRIP], [AVG] or [MAX], and hold down the [information] button until "0" is displayed.
- Gear position display - Compatible products only (A "Di2 Ready" label is affixed to the motor unit of models compatible with SHIMANO Di2).

Display menu, parameters setting:

Basic settings such as the language displayed on the display unit, adjustment of backlight brightness and time can be changed.

Access the basic setting menu, then change the settings as desired. In the basic setting menu, the following items can be switched and set.

Item	Description
[LANGUAGE]	The language displayed on the display unit can be switched. The language can be selected from the following ten languages: English, German, Dutch, French, Italian, Spanish, Finnish, Swedish, Norwegian, Danish
[CONTRAST]	The contrast of the display unit LCD can be adjusted in ten stages.
[BRIGHTNESS]	The brightness of the backlight of the display unit LCD can be adjusted in five stages. The brightness can be set separately for when the night mode indicator is turned on and when it is turned off.
[UNIT]	The display unit for speed and distance can be toggled between kilometers and miles.
[WHEEL]	The tire circumference matched to the electric bicycle currently in use can be set.
[ODO INPUT]	The display of the total distance travelled can be changed.
[CLOCK]	The time can be adjusted.

Setting of [LANGUAGE]



- 1) Hold down the [information] button and the assist mode select button [arrow down] on the operation unit until [LANGUAGE] is displayed at Text indication on the display unit.
- 2) Press the [information] button to set [LANGUAGE].
- 3) Press the assist mode select buttons to select the language you want to change.
 - When holding down the assist mode select buttons for two seconds, the display will change fast.
- 4) Press the [information] button to fix the language.
- 5) Press the night mode button.
 - The changed setting is stored in memory on the display unit.

Setting of [CONTRAST]

The contrast can be adjusted in ten stages between level 1 to level 10. At the level 1, no bar is displayed. When the level rises by one, the number of bars also increases by one. At level 10, nine bars are displayed.

e.g. You want to change the contrast from the level 4 to level 8.



- 1) Hold down the [information] button and the assist mode select button [arrow down] on the operation unit until [LANGUAGE] is displayed at Text indication on the display unit.**
- 2) Press the assist mode select buttons to select [CONTRAST] and press the [information] button to set [CONTRAST].**
 - The screen for level 4 is displayed.
- 3) Press the assist mode select buttons to select the contrast you want to change. Then press the [information] button to fix the contrast.**
 - The screen for level 8 is displayed.
 - When holding down the assist mode select buttons for two seconds, the display will change fast.
 - The set contrast is reflected on the display unit.
- 4) Press the night mode button.**
 - The changed setting is stored in memory on the display unit.

Setting of [BRIGHTNESS]

The brightness can be adjusted in five stages from OFF (no backlight), and level 1 to level 4. One bar is displayed at level 1, three bars are displayed at level 2, six bars at level 3, and nine bars at level 4.

e.g. You want to change the brightness from the level 4 to level 2.



- 1) Hold down the [information] button and the assist mode select button [arrow down] on the operation unit until [LANGUAGE] is displayed at Text indication on the display unit.**
- 2) Press the assist mode select buttons to select [BRIGHTNESS] and press the [information] button to set [BRIGHTNESS].**
 - The screen for level 4 is displayed.
- 3) Press the assist mode select buttons to select the brightness you want to change. Then press the [information] button to fix the brightness.**
 - The screen for level 2 is displayed.
 - When holding down the assist mode select buttons for two seconds, the display will change fast.
 - The set brightness is reflected on the display unit.
- 4) Press the night mode button.**
 - The changed setting is stored in memory on the display unit.

Note

- Backlight setting has a normal mode and night mode. The corresponding backlight setting will change depending on whether the light is turned on or off.

Setting of [UNIT]

e.g. You want to change the unit display from kilometers to miles.



- 1) Hold down the [information] button and the assist mode select button [arrow down] on the operation unit until [LANGUAGE] is displayed at Text indication on the display unit.
- 2) Press the assist mode select buttons to select [UNIT] and press the [information] button to set [UNIT].
- 3) Press the assist mode select buttons to select the mile display. Then press the [information] button to fix the mile display.
- 4) Press the night mode button.
 - The changed setting is stored in memory on the display unit.

Setting of [WHEEL]

e.g. You want to change the wheel circumference to 2,200 mm.



- 1) Hold down the [information] button and the assist mode select button [arrow down] on the operation unit until [LANGUAGE] is displayed at Text indication on the display unit.
- 2) Press the assist mode select buttons to select [WHEEL] and press the [information] button to set [WHEEL].
- 3) Press the [information] button to select the digit to change. Then press the assist mode select buttons to change the number.
 - Each time you press the [information] button, you can select the digit in order of the thousands place, hundreds place, tens place, and one place.
 - Available setting value is between 1,000 mm to 2,499 mm.
 - When holding down the assist mode select buttons for two seconds, the display will change fast.
- 4) Set the value of the one place. Then press the [information] button to fix the number.
- 5) Press the night mode button.
 - The changed setting is stored in memory on the display unit.

Setting of [ODO INPUT]

e.g. You want to change the total distance travelled to 560.5 km.



- 1) Hold down the [information] button and the assist mode select button [arrow down] on the operation unit until [LANGUAGE] is displayed at Text indication on the display unit.
- 2) Press the assist mode select buttons to select [ODO INPUT] and press the [information] button to set [ODO INPUT].
- 3) Press the [information] button to select the digit to change. Then press the assist mode select buttons to change the number.
 - Each time you press the [information] button, you can select the digit in order of the ten-thousands place, thousands place, hundreds place, tens place, one place, and first decimal place.
 - Available setting value is between 0.0 km to 99,999.9 km.
 - When holding down the assist mode select buttons for two seconds, the display will change fast.
- 4) Set the value of the one place. Then press the [information] button to fix the number.
- 5) Press the night mode button.
 - The changed setting is stored in memory on the display unit.

Setting of [CLOCK]



- 1) Hold down the [information] button and the assist mode select button [arrow down] on the operation unit until [LANGUAGE] is displayed at Text indication on the display unit.
- 2) Press the assist mode select buttons to select [CLOCK] and press the [information] button to set [CLOCK].
- 3) Press the [information] button to select the hours or minutes to change. Then press the assist mode select buttons to change the number.
 - The time is displayed in 24-hour format.
 - Each time you press the [information] button, you can select the number in order of the tens place for the hours, the one place for the hours, the tens place for the minutes, and the one place for the minutes.
 - When holding down the assist mode select buttons for two seconds, the display will change fast.

4) Set the value of the one place for minutes. Then press the [information] button to fix the time.

5) Press the night mode button.

- The changed setting is stored in memory on the display unit.
- When the night mode button is pressed, the clock starts to tick from the time changed.

Night mode button

Change the backlight brightness of the display unit. Backlight setting has a normal mode and night mode. Five stages of brightness can be set for each mode.

In night mode, the brightness is lowered compared to normal mode so that glare can be reduced while travelling at night.

Night mode button

Night mode indicator

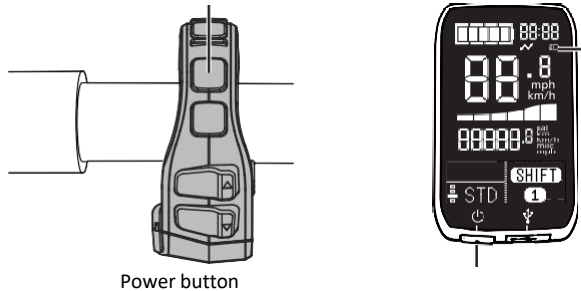

1) Press the power button.

- The electric bicycle system is turned on and the backlight of the display unit lights in normal mode.

2) Press the night mode button.

- The night mode indicator is displayed on the display unit and the backlight changes to night mode. To change to normal mode, press the night mode button again.

Note

- If you set the same brightness for both normal mode and night mode, the brightness does not change even when the mode is switched.
- Set the brightness of the normal mode while the night mode indicator is not displayed. Set the brightness of the night mode while the nightmode indicator is displayed.
- Depending on the specifications of the completed bicycle, if the electric bicycle battery-powered head light or tail lamp is equipped, it will light in night mode.

Charging external devices

You can charge external devices (e.g. mobile phones) that can be connected to the console via the USB cable. Connect the exclusive USB cable to charge for three hours.

External devices can be charged only when the display unit of the console, and a charged battery are mounted on the electric bicycle. Also, the USB cable (commercially available) compatible with the external device is required.

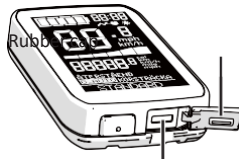

Micro USB port

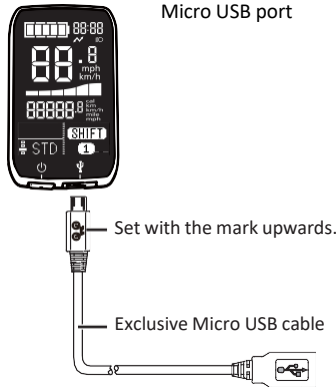

- 1) **Open the cover of the Micro USB port on the display unit of the console.**
- 2) **Connect the exclusive USB cable (optional, Micro USB side: Type B, USB side: male) to the corresponding Micro USB port on the display unit of the console.**
- 3) **Connect the USB cable (commercially available) compatible with the external device to the external device and the exclusive USB cable (optional).**

Attention

- Do not place the external device on a tilted or unstable place while charging. Doing so may cause the device to fall and result a malfunction.
- Some external devices cannot be charged.
- Back up the internal data on the external device since there is the risk that it may disappear.
- Operation has only been verified with some external devices using the exclusive USB cable. There is no guarantee that your external device will work correctly.
- Do not connect the exclusive USB cable (optional) to any devices other than the console. The devices may be damaged.
- Do not charge external devices while travelling. This is dangerous.
- Do not charge external devices in rainy weather or connect a wet USB cable. Doing so may cause a malfunction.
- After using the Micro USB port, firmly close the rubber cap. Otherwise, water may seep in and cause malfunction.

Damaged caused by improper treatment is not within the scope of the warranty.

Maintenance

Regular maintenance:

- maintain all components of the electric bicycle clean
- use only the recommended and tested cleaning materials
- regularly lubricate the chain with suitable oils
- in winter, clean the electric bicycle after each ride and pay increased attention to removing salt from battery contacts and other connectors
- while handling the electric bicycle, make sure the cables of the electric system are not damaged. Damaged cables pose a risk of electric shock
- regularly check all connections for correct tightening and brakes for correct function. Check also individual parts of the electric bicycle for damage. For example: cracks on the frame, fork, handlebars, stem, damage to cables, damage to battery pack, etc.

Battery transport:

Battery transport is subject to the requirements of regulations on dangerous goods. Private users may transport undamaged batteries on roads without having to conform to other conditions.

In case of transport by commercial users or by third parties it is necessary to comply with special packaging and marking requirements (e.g. ADR regulations)

Batteries should only be sent if the battery pack is undamaged. Plug loose contacts and pack the battery to prevent its movement in the packaging. Notify the forwarding service that the transport concerns dangerous goods.

Battery storage:

Store the battery in a dry and well-ventilated place, out of reach of direct sunlight and other heat sources. In case of cold storage it is necessary to let the battery warm up to normal room temperature (20°C) before putting into operation.

Never leave the battery fully discharged. It could result in its permanent damage. For long-term storage keep the battery fully charged. However, do not store it while permanently connected to the charger or installed in the electric bicycle.

Li-Ion batteries are fully recyclable. After expiry of the battery life you can return it at any collection point or your dealer.

If you use an e-bike in hard conditions (long-term use of the maximum assistance), for longer ride at higher temperatures (30 °C or above), in direct sunlight or when the battery is partially discharged and a combination of these situations is it possible that bike will automatically switch off. This is a fuse protecting the control unit against burning. We recommend stop the ride and let the bike (control unit) cool down little bit. This is not a defect.

Possible problems and their solutions

In case of system failure perform its diagnostics or contact your dealer.

The control LCD display is not on:

- always make sure the battery is charged
- check whether the battery is inserted correctly, whether the battery switch is on
- check the connections of the control unit and the display

The motor does not start when pressure applied to the pedal (pedalling)

- if the display shows E1 (the power button was switched while pressure applied on pedal), then press the power button without pedalling to turn on the power.



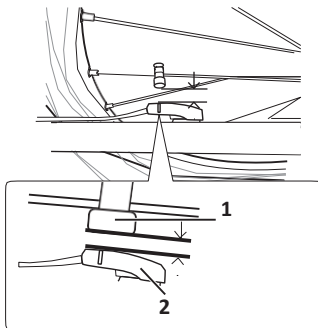

The control LCD display doesn't show speed:







- check the connection of the speed sensor and the control unit.
- check that the clearance between the speed sensor and the magnet unit will be within the specified reading range (1 mm to 15 mm) of the sensor used.
- align the speed sensor and magnet unit as shown in the illustration.

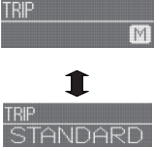
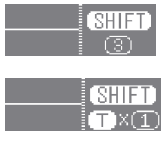
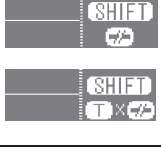

Error codes

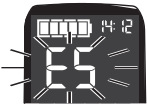
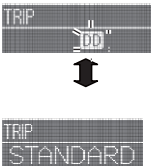
When there is a problem with the electric bicycle, it can show error messages. LCD display will show the error code on the speed display. See Error codes meaning in the table below.

Console	Description	Remedy
	<p>Torque sensor error</p> <ul style="list-style-type: none"> Was the power button pressed while you were pedalling? 	<p>Press the power button without pedalling to turn on the power. If this does not remedy the problem, take the electric bicycle to your dealer.</p>
	<p>Speed sensor error</p> <ul style="list-style-type: none"> The speed sensor cannot detect the signal correctly. 	<p>Turn the power back on again. Check the speed sensor. If this does not remedy the problem, take the electric bicycle to your dealer.</p>
	<p>Battery authentication error</p> <ul style="list-style-type: none"> The battery cannot be recognized as an authentic battery (one provided at purchase). 	<p>Mount the authentic battery (one provided at purchase).</p>
	<p>Motor unit error</p> <ul style="list-style-type: none"> The motor unit is in error. 	<p>Take the electric bicycle to your dealer.</p>
	<p>Battery communication error</p> <ul style="list-style-type: none"> Communication with the battery is not being performed successfully. 	<p>Remove any dirt from the battery terminals. If this does not remedy the problem, take the electric bicycle to your dealer.</p>
	<p>Overheating (motor)</p> <ul style="list-style-type: none"> The mode has entered the protection mode since the motor unit is overloaded. 	<p>Travel under a lighter load. After a short while, the temperature will return to normal, and the assist function will be restored.</p>
	<p>Motor unit error</p> <ul style="list-style-type: none"> The motor unit is in error. 	<p>Take the electric bicycle to your dealer.</p>
	<p>Is the electric wire connector correctly installed?</p>	<p>Check if the electric wire connector is disconnected. Take the electric bicycle to your dealer.</p>

Console	Description	Remedy
	Cradle compatibility error <ul style="list-style-type: none"> The cradle cannot be recognized as an authentic cradle (one provided at purchase). 	Mount the authentic cradle (one provided at purchase).
	Switch authentication error <ul style="list-style-type: none"> The console cannot be authenticated. 	Update the console software to the newest version. Take the electric bicycle to your dealer.
 <p>Backlight blinks.</p>	Switch authentication error <ul style="list-style-type: none"> The console cannot be authenticated. 	Check the cable connections between the console and the motor unit. Check the cradle contacts or display contacts for dirt.
	Switch authentication error <ul style="list-style-type: none"> The console provided at purchase cannot be authenticated. 	Mount the console provided at purchase. If this does not remedy the problem, take the electric bicycle to your dealer.
	Bicycle mark button (Walk assistance) error. <ul style="list-style-type: none"> Either the bicycle mark button (Walk assistance) is pressed or short-circuited. 	Check that the bicycle mark button (Walk assistance) is not pressed. Then press the power button to turn the power back on again. If this does not remedy the problem, take the electric bicycle to your dealer.
	Average speed error <ul style="list-style-type: none"> There is not enough data to calculate the average speed. 	Reset the average speed. * Measurement data such as distance travelled is not recorded while [E] is still displayed, though the power assist function is active.
	EEPROM error <ul style="list-style-type: none"> The console has an error. 	Take the electric bicycle to your dealer.
Entire display blinks.		
	Protective function active <ul style="list-style-type: none"> The protective function against the continuous charging is activated. 	Turn the power off and on. If the display does not disappear even when the power is turned off and on, your device is the unsupported USB device.
	Coin-type battery out of power <ul style="list-style-type: none"> The coin-type battery has run out of power. 	Replace the coin-type battery and set the time.

Electric set warranty

Complaint procedure:

Submit any complaints concerning the electric set or the battery to your dealer.

When filing a complaint, submit a proof of purchase and a warranty certificate with the registered serial number of the battery and indicate the reason for the complaint and a description of the defect.

Warranty conditions:

24 months for electric bicycle components – applies to manufacturing and material defects beyond normal wear and tear caused by use.

12 months for battery life – the nominal battery capacity does not drop below 70 % of the total capacity over 12 months from the sale of the electric bicycle.

Warranty conditions:

The electric set must be used exclusively for the purposes it is intended for.

The electric set must be used, stored and maintained in accordance with these Operating Instructions.

A warranty claim shall expire:

If it is found out that the damage to the product is due to the user's fault (accident, inexpert handling beyond the framework of these Operating Instructions, tampering with the structure of the electric bicycle or connection of the electric system, improper storage etc.).

Expiry of the warranty period.

The warranty only applies to the first owner

Warning

If you do not understand any of the points in these Operating Instructions, please contact the dealer for explanation. Please read the whole manual!

Do not lend the e-bike to persons not briefed in its use and operation. Complaints resulting from improper handling will not be accepted.

The LF Energy electric bicycle is not intended for use by children under 15 years of age. Likewise, the electric bicycle cannot be used by persons unable to pedal or handle it independently. The manufacturer is not to be held responsible for any potential injuries or damage to the bicycle!

Ideal weather conditions for using an electric bicycle are dry days, when the outdoor temperature is above 10°C. When used at lower temperatures, the battery discharges faster due to physical phenomena. Using the electric bicycle at temperatures below 0°C is not recommended.

Do not expose the bicycle to direct sunlight as it is fitted with a protective temperature sensor for the electric motor.

Never submerge the battery, the charger and other electric components in water or another liquid.

Never wash the electric bicycle in a pressure washer (WAP) and always remove the battery before washing

It is forbidden to tamper with the connections of the electric motor, the control unit and the battery. Violating this section may result in the warranty not being acknowledged or in irreversible damage to the electric bicycle.

DO NOT USE chargers and components other than the ones included with the electric bicycle.

We cannot be held responsible for damage caused by use of other non-approved goods

bohemia**bike**

b i k e f a c t o r y

Na Pankráci 1724, 140 00 Praha 4 - Pankrác, IČ: 63910756

EU PROHLÁŠENÍ O SHODĚ

Prohlašujeme, že elektrokola značky Leader fox, dodávané na český i zahraniční trh společností Bohemia bike a.s. jsou v souladu s platnými českými technickými normami ČSN EN ISO 4210-2 i ustanovením evropských směrnic EN 15194:2017, 2006/42/EC A 2014/30/EU pro jízdní kola s pomocným elektrickým motorem tzv. EPAC. Výrobky jsou v souladu se směrnicí na strojní zařízení 2006/42/ES (NV 176/2008 Sb.) Tato vyrobená strojní zařízení splňují všechna příslušná ustanovení předmětného předpisu EU.

Seznam výrobků obsahuje příloha dokumentu:

V Českých Budějovicích 1. ledna 2020

bohemia bike a.s.

IČ: 63910756, DIČ: CZ63910756
Na Pankráci 1724, 140 00 Praha 4 - Pankrác
CZECH REPUBLIC (8)

.....
Pavel Müller, předseda představenstva a odpovědná osoba za veškerou tech. dokumentaci

LEADER FOX



Enjoy many pleasant and safe kilometres on your new electric bicycle.

Your Leader Fox Team



**Czech brand of electric bicycles.
BOHEMIA BIKE**

Adress

Pujmanové 1753/10a, Nusle
14000 Praha 4 – Pankrác

Development, design and manufacturing

Okružní 697
České Budějovice 37001

Phone: 388 314 885
Email: info@leaderfox.cz

