

LEADER FOX

Electric Bicycle Operating Instructions

Under the law, the dealer is obliged to attach the LEADER FOX Electric Bicycle Operating Instructions to every product

E – BIKE POWER RIDE

Induktora

Lotus

Dear users,

Please read carefully all the information regarding your E-LF product to ensure optimal functioning of your e-bike. The following text containing a comprehensive description will provide you with information on all aspects and details (including installation, setting up and general use of the display) regarding the use of our display. This instruction document will also help you solve potential problems and failures.

What is an electric bicycle?



Electric bicycle is a conventional bicycle with an electric drive added to assist the rider. The motor function is actuated by pedalling, which is scanned by a special sensor installed in the pedal hub. Therefore, you have to keep pedalling on an e-bike, the motor is there only to help you. You can set an electric bicycle in motion also using a control button or an accelerator but only up to the maximum permitted speed of 6 KMPH (e.g. for walk assistance). The maximum speed of an e-bike with motor assistance is 25 KMPH, with a 10% tolerance (when this speed limit is reached, the motor switches off and you need to pedal just like with a regular bicycle). When your battery runs out of power or your motor is off, you can ride your electric bicycle as a conventional bike, without any resistance at all.

From the point of view of the Road Traffic Act, an electric bicycle whose features conform to European standard EN 15194-1 is regarded as a regular bicycle, i.e. you can ride on bike trails, do not need a driver's license and a helmet is mandatory only up to 18 years of age.



Factors influencing the electric bicycle range

- 1. Rolling resistance of the tyres.** Leader Fox e-bikes are fitted with tyres with low rolling resistance and increased resistance to puncture. It is also important that the tyres are inflated properly. Therefore, if the tyres of your electric bicycle are underinflated, the range will decrease.
- 2. Weight of the electric bicycle.** The lower weight of the electric bicycle, the greater the range.
- 3. Battery status.** It depends on whether the battery was fully charged before your trip. It is also to be expected that the higher the number of discharge cycles the battery has undergone, the smaller capacity it has.
- 4. Profile and surface of the track.** The higher the elevation difference and the steeper hills you negotiate and the worse surface, the shorter the range.
- 5. Riding mode.** It depends on which of the three riding modes you have set.
- 6. Continuity of riding.** The more braking and acceleration, the shorter the range.
- 7. Air resistance.** For example, it depends on whether we ride a bicycle with low frame and sitting upright or whether we ride sporty bicycle with seat set to the same height as the handlebars.
- 8. Wind strength.** The stronger the wind we have back, the longer the range and vice versa.
- 9. Weight of the rider and load.** The greater the weight, the shorter the range.
- 10. External temperature.** The lower the temperature, the less battery capacity can be used while riding.

Safety instructions

Battery:

- Do not throw the battery into fire.
- Do not throw the battery into water.
- Do not use the battery for other appliances. It has been made specifically for this model.
- Do not dismantle or modify the battery.
- Do not connect the positive and negative poles of the battery.

Charger:

- Do not dismantle or modify the charger.
- Do not use the charger for other appliances. It has been made specifically for this model.
- Do not throw the charger into fire or water.
- Do not touch the charger with wet hands.
- Keep the charger from animals or children.
- Do not cover the charger.
- Do not use the charger if it is broken.

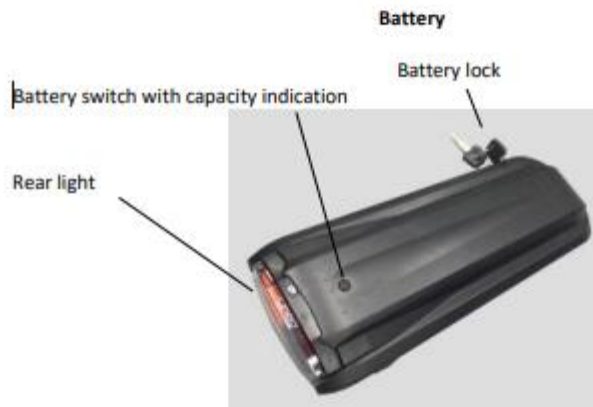

Battery

Battery charging and maintenance:

Charge the battery in a dry environment to avoid short-circuit damage.
Charge the battery to at least 60% of the capacity once every 3 months even when the bicycle is not used.
Do not cover the battery or the charger.
Do not leave the battery constantly connected to the power source.
Do not use the battery for other appliances. It has been made specifically for this model.
Do not disassemble or modify the battery pack.
Do not throw the battery into fire or expose it to extreme temperatures.
Recharging time from zero to 100% is 1-7 hours.

Drive warranty:

The warranty applies to those drive parts that are not sensitive to improper handling (pack, electronics, charger, etc.); such parts are covered by a 24-month warranty.
The warranty does not apply to chemical parts of the battery and to capacity reduction due to normal use (39% after the expiry of two years); those parts are covered by a 12-month warranty.

Charging:

The battery is the most expensive part of an electric bicycle; therefore, pay increased attention during handling, charging and storage. The battery is sensitive to precise charging. Therefore, it is necessary to charge Li-Ion rechargeable batteries using only a charger supplied by us. Connect the charger to 220-240 V power outlet. 5A protected circuit is sufficient. The charger will automatically suspend charging when full capacity of all cells is reached.

We recommend discharging the battery in full after each ride to ensure that your battery will be up to its full capacity for your next ride. Charging the battery may last 1 to 5 hours depending on the condition of the battery cells. Charge it exclusively in covered dry areas (moisture and dripping water can damage the charger) at a temperature of 5 to 40°C.

The charging process is indicated by a red glowing LED. It will turn green when the battery is charged and the charging process is complete. The battery contains a charge-monitoring indicator (when the charge indicator button is pressed, the light indicator will come on).

Normal battery behaviour:

If the motor stops running smoothly and switches to intermittent operation, it could be a sign of low battery capacity. In that case switch off the electric drive system and continue without motor assistance, as if riding a conventional bicycle.

Battery warming is normal and does not indicate any defect. The battery is protected by a temperature sensor and switches off automatically in case of excessive overheating. Wait until the battery cools down to its normal operating temperature and then ride on.

If you feel your total battery capacity has dropped, it could be caused by charging or operation in suboptimal climatic conditions. Carry out 3 full charging cycles. Fully discharge the battery while riding and then charge to its full capacity at room temperature.

If the charge indicator shows that the battery is discharged, there is still a minimum voltage level in it

which protects it against damage but is not enough to power the electric bicycle. Recharge the battery as soon as possible. Never leave the battery fully discharged, it could result in its damage.

If you switch on the battery by POWER button the rear light will switch on too. The light is on from safety point whole the time. If you want to switch off it, you have to switch off whole bike by POWER button on the top side of the battery.

In the case, that the battery will be turned on more than 30 min and bike will not be used, the battery will be automatically switched off.

Battery is fully shutdown after 48h. After that time period you have to first activate the battery by switch button or connect battery with charger.

Proper care of the battery prolongs its life.

LCD display

Product Name:

Middle Install APT450U Intelligent LCD Display

Supplier:

Tianjin APT Development Cop., Ltd.

Electrical Parameters:

Battery supply: 36 V
Rated operating current: 10 mA
Maximum operating current: 30 mA
Off-state leakage current: < 1 uA
Maximum output current to the controller: 50 mA
Operating temperature - 20 ~ 70 °C
Storing temperature - 30 ~ 70 °C

Certification:

CE/IP65 (waterproof)/ROHS Directive

LCD Display materials, dimensions and description:

The casing is made from ABS (Acrylonitrile Butadiene Styrene) and the see-through part is made from a very firm acrylate with the stiffness of toughened glass



LCD display description:

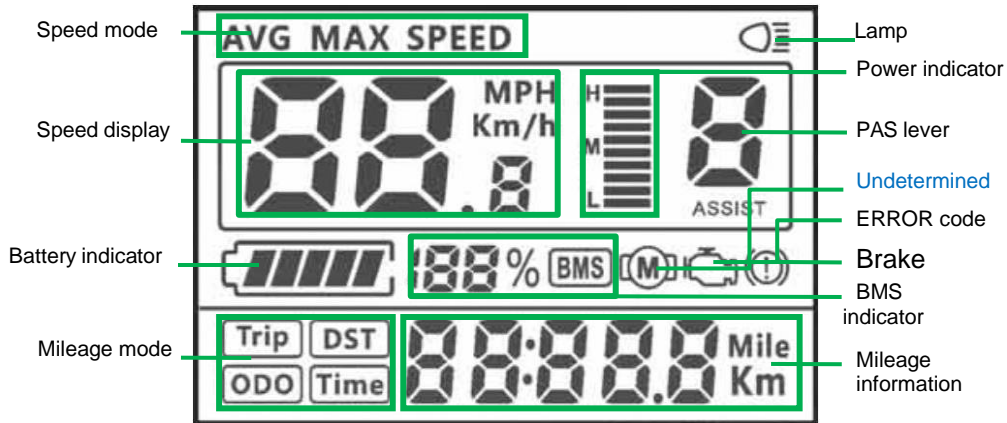

Speed mode - AVG Speed (average speed), MAX Speed (maximum speed), Speed (current speed).

Speed display - Kilometres/miles. Can be set as per user preferences.

Battery Indicator - Intelligent battery status indicator.

Mileage mode – Indication of travelled distance (Trip), total number of kilometres travelled (ODO), travelling time (Time), expected mileage distance. (DST).

Lamp – Indication of switch on/off light and display backlight.

Power indicator - Instantaneous engine power.

PAS level - 7 levels of pedal assist system (PAS).

Undetermined – not specified

Error code – error code indicator

Brake – not specified

BMS indicator – BMS (battery control system): The BMS indicator, battery charge percentage, it displays the mileage indicator (it needs access to the BMS information system support).

Mileage information – Indication of travelling

Maximum range:

The maximum range of the bike is calculated with fully-charged battery in flat terrain and with weak head wind. The average range of the bike is calculated with ideal mode switching and slightly hilly terrain.

Controller

Controller description:



Assembly and disassembly

Display assembly:

Please pay attention to the tightening torque of the screws. Before assembly and during disassembly of the display, it is necessary to remove the grip and if needed also to remove the brake lever, gear lever and display from the handlebar. Damage caused by excessive tightening or incorrect assembly/disassembly is not covered by the warranty.

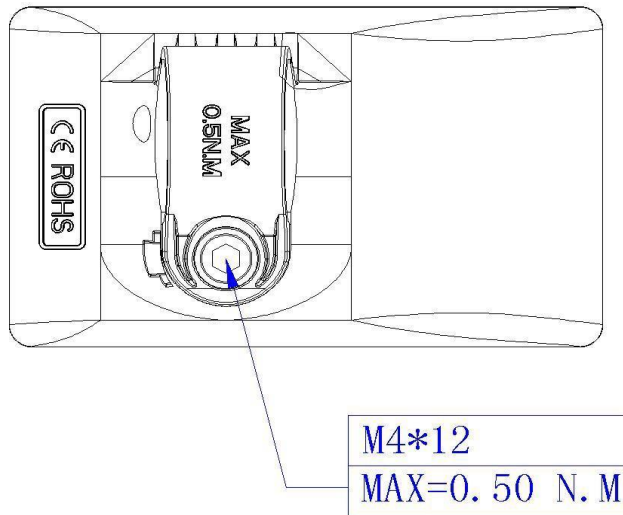

Output Wiring Connection:

- 1 - Red conductor: Positive pole (24V/36V)
- 2 - Blue conductor: Supply cable to the controller
- 3 - Black conductor: GND (earthing)
- 4 - Green conductor: RxD (from the controller to the display)
- 5 - Yellow conductor: TxD (from the display to the controller)

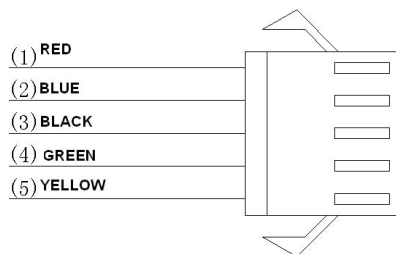

Control

Switching on the electric system of the bicycle:

Before switching the system on, check connections of the electric cables.

Press the switch on the battery for supply of the electric system on the frame battery.

Switch on the control panel of the electric bicycle on the panel (attached to the handlebar) by pressing the ON/OFF button and holding it for 1.5 seconds. The display will switch off automatically if it is not used (the e-bike is not in motion) for a certain time (the timer can be set in the range of 0 ~ 7 minutes).

Press and hold the Up button to switch the display back light on.

After riding, always switch the electric bicycle off in the same way.

Assistance mode settings:

Press the Up/Down buttons to change the PAS level. The highest PAS level is 7. 0 means no use of PAS. (we are not using 9 PAS as you can see on illustration below). If you switch from 0 to 1 it is necessary to pedal one or two times backwards for activating the pedal sensor.



Walking assistant:

This feature assists with walking and pushing the electric bicycle. Press and hold the Down button for 2 seconds to switch to the walking mode (6 km/h). Release the button to switch the mode off.

Battery status indicator:

Shows approximate remaining battery capacity. The battery is fully charged when all the LED lights are on. You can see the precise capacity on the indicator directly on the battery.

Erasing data:

Press and hold the Up and Down buttons at the same time for 1 second to reset some of the temporary data, such as AVG Speed (average speed), MAX Speed (maximum speed), Trip and Time.

Changing between Speed mode and Mileage mode:

Press the POWER button to change the Speed mode and Mileage mode.

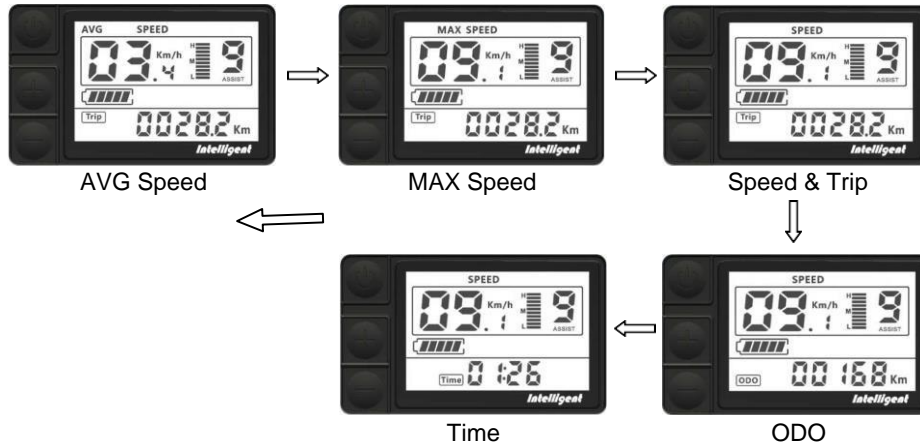

Headlight/Backlight On/Off:

Press and hold UP button for 1 second can turn on/off the headlight and the screen will switch to the corresponding mode.

The motor does not work when battery voltage is low. Display still can keep the headlight on for a while when e-bike is in riding.

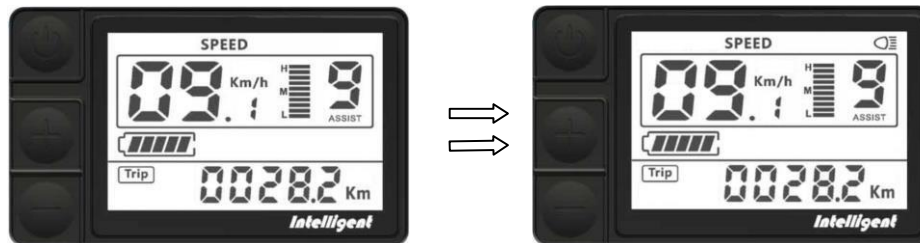

Data cleanup:

Press and hold UP and DOWN button together for 1 second can reset several temporary data, temporary data include AVG speed/MAX speed/Trip/Time.

Control

Parameter settings:

Press the Power button twice quickly (faster than in 0.3 second) to activate the parameter settings mode; the parameter is flashing.

Press the Up/Down button shortly to change the value of the parameter. Press the Power button shortly to switch to another parameter.

You can leave the parameter settings the same way.

The display will automatically quit the parameter setting mode if no button is pressed for 10 seconds.

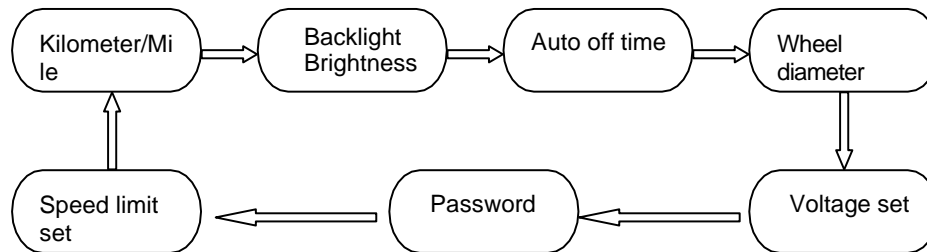

Kilometer/Mile (S7)

Press UP/DOWN buttons to change the Km/h / MPH.

Backlight brightness (bL1)

Press UP/DOWN buttons to change the brightness 1-5.

Automatické vypnutí (OFF)

Press UP/DOWN buttons to change the automatic off time in minutes.

Wheel diameter (Wd)

Wheel diameter is set according to the manufacturer. Press UP/DOWN buttons to change the 16/18/20/22/24/26/700C/28/29.

Voltage setting (bU0)

Default voltage setting is set according to the manufacturer. Press UP/DOWN buttons to change the 24V/36V/Ube.

**System is factory set. For changing these parameters contact your dealer or producer.
Do not change these parameters by yourself, you can damage the e-bike.
Damaged caused by improper treatment is not within the scope of the warranty.**

Maintenance

Regular maintenance:

- maintain all components of the electric bicycle clean
- use only the recommended and tested cleaning materials
- regularly lubricate the chain with suitable oils
- in winter, clean the electric bicycle after each ride and pay increased attention to removing salt from battery contacts and other connectors
- while handling the electric bicycle, make sure the cables of the electric system are not damaged. Damaged cables pose a risk of electric shock
- regularly check all connections for correct tightening and brakes for correct function. Check also individual parts of the electric bicycle for damage. For example: cracks on the frame, fork, handlebars, stem, damage to cables, damage to battery pack, etc.
- always remove the battery before transporting the electric bicycle on or in a car

Battery transport:

Battery transport is subject to the requirements of regulations on dangerous goods. Private users may transport undamaged batteries on roads without having to conform to other conditions.

In case of transport by commercial users or by third parties it is necessary to comply with special packaging and marking requirements (e.g. ADR regulations)

Batteries should only be sent if the battery pack is undamaged. Plug loose contacts and pack the battery to prevent its movement in the packaging. Notify the forwarding service that the transport concerns dangerous goods.

Battery storage:

Store the battery in a dry and well-ventilated place, out of reach of direct sunlight and other heat sources. In case of cold storage it is necessary to let the battery warm up to normal room temperature (20°C) before putting into operation.

Never leave the battery fully discharged. It could result in its permanent damage. For long-term storage keep the battery fully charged. However, do not store it while permanently connected to the charger or installed in the electric bicycle.

Li-Ion batteries are fully recyclable. After expiry of the battery life you can return it at any collection point or your dealer.

If you use an e-bike in hard conditions (long-term use of the maximum assistance), for longer ride at higher temperatures (30 ° C or above), in direct sunlight or when the battery is partially discharged and a combination of these situations is it possible that bike will automatically switch off. This is a fuse protecting the control unit against burning. We recommend stop the ride and let the bike (control unit) cool down little bit. This is not a defect.

Possible problems and their solutions



In case of system failure perform its diagnostics or contact your dealer.

The control LCD display is not on:

- always make sure the battery is charged
- check whether the battery is inserted correctly, whether the battery switch is on
- check the connections of the control unit and the display

The motor does not start when the walk assistance button is pressed

- check the connection of the motor cable (at the motor and the control unit)
- check the connections of the control unit and the display

The motor does not start when rotating the pedal cranks (pedalling)

- check the connection of the pedalling sensor to the control unit
- check the distance between the pedalling sensor and the magnet disk (max. 4 mm)
- check whether the disk is firmly attached to the central axle and does not spin freely
- in case of use of compact-type pedalling sensor

Warning

When there is a problem with the electric bicycle, it can show error messages. LCD display will show the icon and an error code will be displayed on the speed display. Error codes are marked from 01 E~FF E; see their meaning in the table below.

Error code	Description	Solution
1	Communication error	Check the cable connection
2	Regulator protection	Check the three-phase electric line
3	Three-phase supply error	Check the three-phase connection
4	Low battery	Charge the battery
5	Brake error	Check the brake connection
6	Turn error	Check the turn connection
7	Hall probe error	Check the hall probe connection

Assembly and disassembly of the wheel with the engine

For transportation and maintenance (replacing the tire tube) it may sometimes be necessary to disassemble the wheel with the engine.

First, pull lightly to disconnect the engine connector (about 20 cm from the engine entry).

Then loosen the brake (if it is used) and change the gear to the smallest wheel.

Remove the rubber covers from the wheel nuts.

Loosen the engine nut using a spanner size 18 and remove the wheel from the frame.

For assembly, reverse the order of these steps.

To connect the connector properly, the arrows on the connector (1) must face each other.

Switch the drive unit on and test it.

During wheel assembly, pay attention to the proper position of the central axis of the wheel nave facing down. The cable must enter the engine from below. Otherwise, water could get into the engine on the cable and the engine could be damaged.

Electric set warranty



Complaint procedure:

Submit any complaints concerning the electric set or the battery to your dealer.

When filing a complaint, submit a proof of purchase and a warranty certificate with the registered serial number of the battery and indicate the reason for the complaint and a description of the defect.

Warranty conditions:

24 months for electric bicycle components – applies to manufacturing and material defects beyond normal wear and tear caused by use.

12 months for battery life – the nominal battery capacity does not drop below 70% of the total capacity over 12 months from the sale of the electric bicycle.

Warranty conditions:

The electric set must be used exclusively for the purposes it is intended for.

The electric set must be used, stored and maintained in accordance with these Operating Instructions.

A warranty claim shall expire:

If it is found out that the damage to the product is due to the user's fault (accident, inexpert handling beyond the framework of these Operating Instructions, tampering with the structure of the electric bicycle or connection of the electric system, improper storage, etc.).

Expiry of the warranty period.

The warranty only applies to the first owner

Warning

If you do not understand any of the points in these Operating Instructions, please contact the dealer for explanation. Please read the whole manual!

Do not lend the e-bike to persons not briefed in its use and operation. Complaints resulting from improper handling will not be accepted.

The LF Energy electric bicycle is not intended for use by children under 15 years of age. Likewise, the electric bicycle cannot be used by persons unable to pedal or handle it independently. The manufacturer is not to be held responsible for any potential injuries or damage to the bicycle!

Ideal weather conditions for using an electric bicycle are dry days, when the outdoor temperature is above 10°C. When used at lower temperatures, the battery discharges faster due to physical phenomena. Using the electric bicycle at temperatures below 0°C is not recommended.

Do not expose the bicycle to direct sunlight as it is fitted with a protective temperature sensor for the electric motor.

Never submerge the battery, the charger and other electric components in water or another liquid.

Never wash the electric bicycle in a pressure washer (WAP) and always remove the battery before washing.

It is forbidden to tamper with the connections of the electric motor, the control unit and the battery. Violating this section may result in the warranty not being acknowledged or in irreversible damage to the electric bicycle.

DO NOT USE chargers and components other than the ones included with the electric bicycle.

We cannot be held responsible for damage caused by use of other non-approved goods.

bohemia**bike**

b i k e f a c t o r y

Na Pankráci 1724, 140 00 Praha 4 - Pankrác, IČ: 63910756

EU PROHLÁŠENÍ O SHODĚ

Prohlašujeme, že elektrokola značky Leader fox, dodávané na český i zahraniční trh společností Bohemia bike a.s. jsou v souladu s platnými českými technickými normami ČSN EN ISO 4210-2 i ustanovením evropských směrnic EN 15194:2017, 2006/42/EC A 2014/30/EU pro jízdní kola s pomocným elektrickým motorem tzv. EPAC. Výrobky jsou v souladu se směrnicí na strojní zařízení 2006/42/ES (NV 176/2008 Sb.) Tato vyrobená strojní zařízení splňují všechna příslušná ustanovení předmětného předpisu EU.

Seznam výrobků obsahuje příloha dokumentu:

V Českých Budějovicích 1. ledna 2020

bohemia bike a.s.

IČ: 63910756, DIČ: CZ63910756
Na Pankráci 1724, 140 00 Praha 4 - Pankrác
CZECH REPUBLIC (8)

.....
Pavel Müller, předseda představenstva a odpovědná osoba za veškerou tech. dokumentaci

LEADER FOX



Enjoy many pleasant and safe kilometres on your new electric bicycle.

Your Leader Fox Team



**Czech brand of electric bicycles.
BOHEMIA BIKE**

Address

Pujmanové 1753/10a
140 00 Praha 4 - Nusle

Development, design and manufacturing

Okružní 697
České Budějovice 37001

Phone: 388 314 885
Email: info@leaderfox.cz

