

LEADER FOX



Electric Bicycle Operating Instructions

Under the law, the dealer is obliged to attach the LEADER FOX Electric Bicycle Operating Instructions to every product



E – BIKE POWER RIDE

Sandy



Introduction

Dear users,

Please read carefully all the information regarding your E-LF product to ensure optimal functioning of your e-bike. The following text containing a comprehensive description will provide you with information on all aspects and details (including installation, setting up and general use of the display) regarding the use of our display. This instruction document will also help you solve potential problems and failures.

What is an electric bicycle?

Electric bicycle is a conventional bicycle with an electric drive added to assist the rider. The motor function is actuated by pedalling, which is scanned by a special sensor installed in the pedal hub. Therefore, you have to keep pedalling on an e-bike, the motor is there only to help you. You can set an electric bicycle in motion also using a control button or an accelerator but only up to the maximum permitted speed of 6 KMPH (e.g. for walk assistance). The maximum speed of an e-bike with motor assistance is 25 KMPH, with a 10% tolerance (when this speed limit is reached, the motor switches off and you need to pedal just like with a regular bicycle). When your battery runs out of power or your motor is off, you can ride your electric bicycle as a conventional bike, without any resistance at all.

From the point of view of the Road Traffic Act, an electric bicycle whose features conform to European standard EN 15194-1 is regarded as a regular bicycle, i.e. you can ride on bike trails, do not need a driver's license and a helmet is mandatory only up to 18 years of age.

Description



Factors influencing the electric bicycle range

- 1. Rolling resistance of the tyres.** Leader Fox e-bikes are fitted with tyres with low rolling resistance and increased resistance to puncture. It is also important that the tyres are inflated properly. Therefore, if the tyres of your electric bicycle are underinflated, the range will decrease.
- 2. Weight of the electric bicycle.** The lower weight of the electric bicycle, the greater the range.
- 3. Battery status.** It depends on whether the battery was fully charged before your trip. It is also to be expected that the higher the number of discharge cycles the battery has undergone, the smaller capacity it has.
- 4. Profile and surface of the track.** The higher the elevation difference and the steeper hills you negotiate and the worse surface, the shorter the range.
- 5. Riding mode.** It depends on which of the three riding modes you have set.
- 6. Continuity of riding.** The more braking and acceleration, the shorter the range.
- 7. Air resistance.** For example, it depends on whether we ride a bicycle with low frame and sitting upright or whether we ride sporty bicycle with seat set to the same height as the handlebars.
- 8. Wind strength.** The stronger the wind we have back, the longer the range and vice versa.
- 9. Weight of the rider and load.** The greater the weight, the shorter the range.
- 10. External temperature.** The lower the temperature, the less battery capacity can be used while riding.

Safety instruction

Battery:

- Do not throw the battery into fire.
- Do not throw the battery into water.
- Do not use the battery for other appliances. It has been made specifically for this model.
- Do not dismantle or modify the battery.
- Do not connect the positive and negative poles of the battery.

Charger:

- Do not dismantle or modify the charger.
- Do not use the charger for other appliances. It has been made specifically for this model.
- Do not throw the charger into fire or water.
- Do not touch the charger with wet hands.
- Keep the charger from animals or children.
- Do not cover the charger.
- Do not use the charger if it is broken.



Charging set



Battery

Battery charging and maintenance:

Charge the battery in a dry environment to avoid short-circuit damage.

Charge the battery to at least 60% of the capacity once every 3 months even when the bicycle is not used.

Do not cover the battery or the charger.

Do not leave the battery constantly connected to the power source.

Do not use the battery for other appliances. It has been made specifically for this model.

Do not disassemble or modify the battery pack.

Do not throw the battery into fire or expose it to extreme temperatures.

Recharging time from zero to 100% is 1-7 hours.

Drive warranty:

The warranty applies to those drive parts that are not sensitive to improper handling (pack, electronics, charger, etc.); such parts are covered by a 24-month warranty.

The warranty does not apply to chemical parts of the battery and to capacity reduction due to normal use (39% after the expiry of two years); those parts are covered by a 12-month warranty.

Charging:

The battery is the most expensive part of an electric bicycle; therefore, pay increased attention during handling, charging and storage. The battery is sensitive to precise charging. Therefore, it is necessary to charge Li-Ion rechargeable batteries using only a charger supplied by us. Connect the charger to 220-240 V power outlet. 5A protected circuit is sufficient. The charger will automatically suspend charging when full capacity of all cells is reached.

We recommend discharging the battery in full after each ride to ensure that your battery will be up to its full capacity for your next ride. Charging the battery may last 1 to 5 hours depending on the condition of the battery cells. Charge it exclusively in covered dry areas (moisture and dripping water can damage the charger) at a temperature of 5 to 40°C.

The charging process is indicated by a red glowing LED. It will turn green when the battery is charged and the charging process is complete. The battery contains a charge-monitoring indicator (when the charge indicator button is pressed, the light indicator will come on). Always switch off the battery when finished riding the bike.

Normal battery behaviour:

If the motor stops running smoothly and switches to intermittent operation, it could be a sign of low battery capacity. In that case switch off the electric drive system and continue without motor assistance, as if riding a conventional bicycle.

Battery warming is normal and does not indicate any defect. The battery is protected by a temperature sensor and switches off automatically in case of excessive overheating. Wait until the battery cools down to its normal operating temperature and then ride on.

If you feel your total battery capacity has dropped, it could be caused by charging or operation in suboptimal climatic conditions. Carry out 3 full charging cycles. Fully discharge the battery while riding and then charge to its full capacity at room temperature.

If the charge indicator shows that the battery is discharged, there is still a minimum voltage level in it which protects it against damage but is not enough to power the electric bicycle. Recharge the battery as soon as possible. Never leave the battery fully discharged, it could result in its damage.

In the case, that the battery will be turned on more than 30 min and bike will not be used, the battery will be automatically switched off.

Proper care of the battery prolongs its life.



KEY-DISP

eBike Display

User Manual

KD686

Product Name and Model

Intelligent ebike color display; Model: **KD686 (UART)**

Specification

- 2.0" IPS color screen
- 36V/48V/52V power supply power supply
- Meter rated operating current: 22mA
- Shutdown leakage current: <1uA
- Operating temperature: -10~ 60°C
- Storage temperature: -20 to 70°C

Exterior Dimensions

Physical drawing and dimensional drawing of the display (unit: mm)

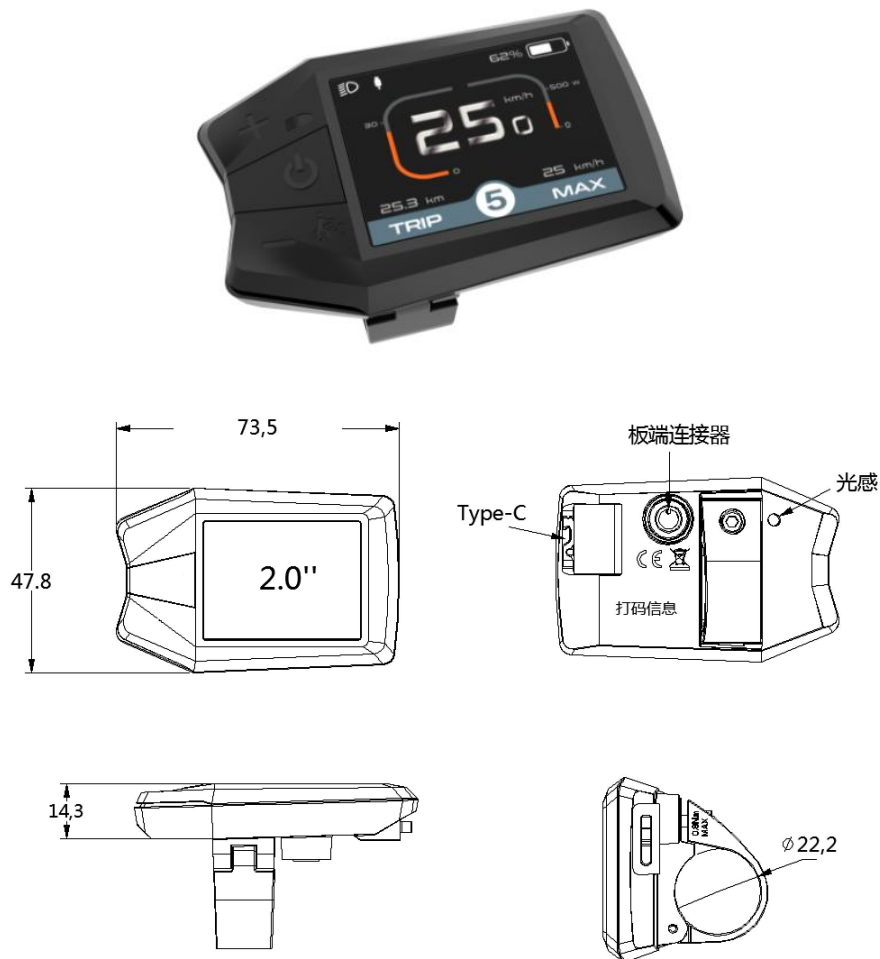

The KD686 model gauges offer a variety of features to meet your riding needs, including:

- Intelligent power indication: real-time voltage/power percentage
- Intelligent display: single mileage TRIP, total mileage ODO, real-time

speed SPEED, maximum speed MAX, average speed AVG, riding time Time

- Motor output power display
- Assisted gear adjustment and display
- Backlight control and headlight display
- walk assistance
- Error code display.
- Type-C charging function
- Light-sensitive function
- Multiple parameter settings (e.g. single mileage clearing, backlighting, metric/imperial system, power setting, gear setting, wheel diameter speed limit setting, power-on password setting, etc.)
- Restore factory default settings
- Error code display
- Bluetooth function (optional)

display area

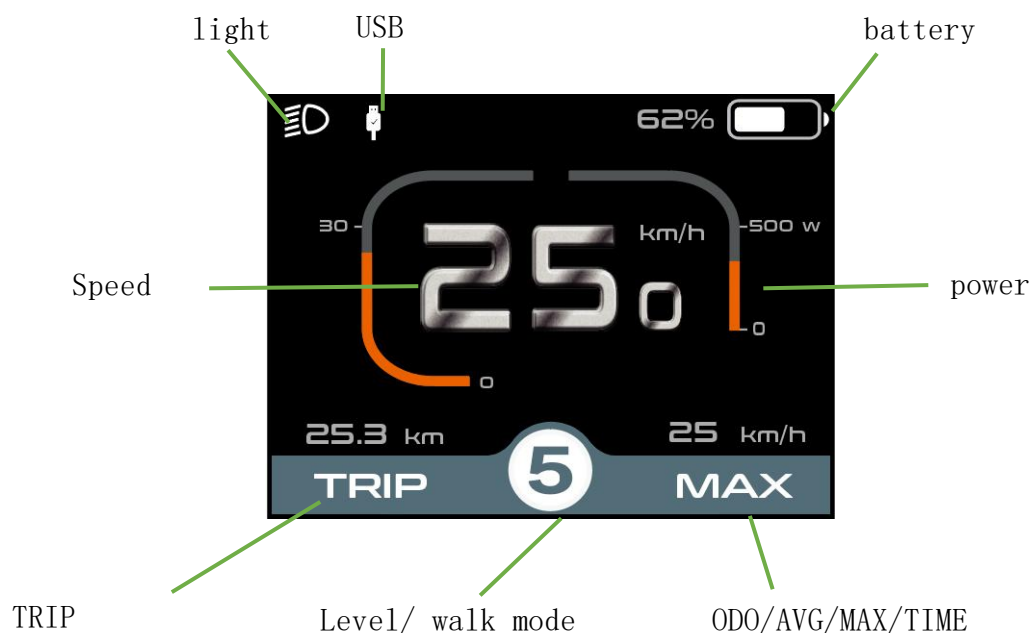

◆ Button Definition

The KD686 display has three buttons: ON/OFF, UP/HEADLIGHT, and DOWN/BUZZER; in subsequent instructions, ON/OFF is replaced by the words "ON/OFF", UP/HEADLIGHT is replaced by the word "UP", and DOWN/BOOSTER is replaced by the word "DOWN". The word "DOWN" is used instead of "ON/OFF" for ON/OFF, "UP" for UP/HEADLIGHT, and "DOWN" for DOWN/WALK BOOST.

General operation

◆ Power on/off

After long pressing the power button, the meter starts to work and provides the working power for the controller. In the power-on state, long press the power button to turn off the power of the EV. In the off state, the meter no longer uses the power from the battery and the leakage current of the meter is less than 1uA.

■ **The meter will automatically turn off if the electric vehicle is not used for more than 5 minutes.**

◆ Display Interface

After the meter is turned on, the meter defaults to display real-time speed, single mileage, total mileage, power, charge, and gear.

Short press "ON/OFF" button can switch between single mileage total mileage ODO (km), maximum speed MAX (km/h), average speed AVG (km/h), time (min).

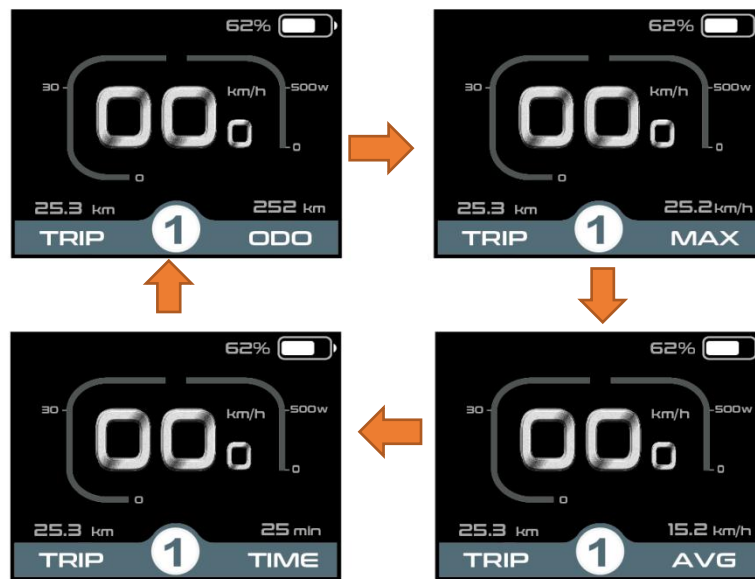

Display interface switching

◆ Walk mode

Press and hold the "DOWN" button, after 2 seconds, the electric vehicle enters the state of electrically assisted driving. The electric vehicle is traveling at a constant speed of not more than 6Km/h. At the same time, the screen displays "  ". Release the "DOWN" button, the electric vehicle will stop power output immediately and return to the state before walk mode is engaged.



Walk mode

◆ **Light-sensitive function and manual on/off backlighting**

The display has a light-sensitive function, which can sense the light and darkness of external light and turn on/off the headlights automatically. When the external light is not enough or when driving at night, the backlight of the display **will be dimmed**, and at the same time notify the controller to turn on the headlights; when the external light is enough, the backlight of the display **will be brightened**, and at the same time notify the controller to turn off the headlights.

Press and hold the **UP** button manually for more than 2 seconds, the display performs the on/off headlight function, and the light sensing function is disabled at the same time.



Turn on the backlit display interface

◆ **assist level selection**

Short press the **"UP"** or **"DOWN"** button to switch the assist levels, change the motor output power. The default output power range of the meter is 0-5, 0 is stop power output, 1 is the lowest power, 5 is the highest power.



Assist level Interface

◆ Battery SOC

Display battery voltage 36V; 36V voltage segments: 31.5V-34.5V-35.6V-37.4V-39.2V

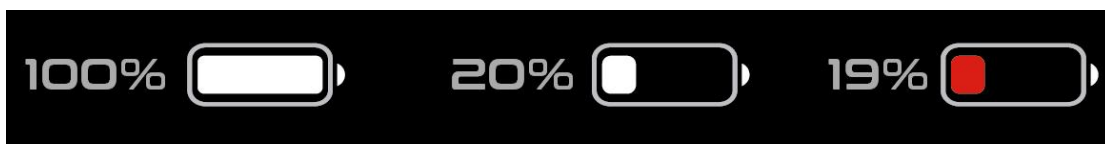

Battery SOC interface

◆ Motor power indication

The meter displays a progress bar of motor output power. The display is shown below.



Motor power display interface

◆ Error Code Display

When there is a malfunction in the electric control system of the electric vehicle, the meter will display an error code, refer to **Exhibit 1** for detailed error code definitions.



Error Code Display Screen

■ When an error code is displayed, please troubleshoot the problem in time, the electric car will not be able to run normally after a malfunction.

General Parameter Settings

In the power-on state, the vehicle is stationary, press and hold the "UP" and "DOWN" buttons at the same time for more than 2 seconds, the display will enter the setting interface.

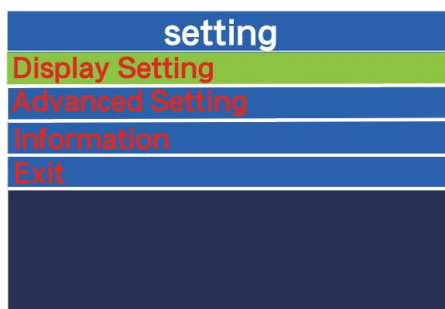

● Display Setting

◆ TRIP RESET

Short press "ON/OFF" to confirm, short press "UP" or "DOWN" to toggle "NO (not clear)" and "YES (clear)"; (Clear data including maximum speed (MAX), average speed (AVG), single mileage (TRIP), riding time (T). " and "YES (clear)"; (clear data including maximum speed (MAX), average speed (AVG), single mileage (TRIP), riding time (Time)), after confirming, press "ON/OFF" again briefly to save and exit to "ON/OFF", then press "UP" or "DOWN" to save and exit to "ON/OFF". After confirming, press "ON/OFF" briefly again to save and exit to "Trip reset", the display defaults to "Trip reset-NO".

Display Setting	
Trip reset	No
Unit	Metric
Brightness	100%
SOC View	percent
Auto Off	5Min
AL Sensitivity	5
Set Voltage	36V
Password	>



Display Setting	
Trip reset	YES
Unit	Metric
Brightness	100%
SOC View	percent
Auto Off	5Min
AL Sensitivity	5
Set Voltage	36V
Password	>

Single Mileage Zero Setting

◆ **units**

Short press "UP" or "DOWN" to select "Unit", short press "ON/OFF" to enter the Setting, press "UP" or "DOWN" to select "Metric" (kilometer)/"Imperial (mile)", press "ON/OFF" to enter the setting. Select "Metric"/"Imperial" by pressing "UP" or "DOWN", press "ON/OFF" to save and exit to "Unit".

Display Setting	
Trip reset	No
Unit	Metric
Brightness	100%
SOC View	percent
Auto Off	5Min
AL Sensitivity	5
Set Voltage	36V
Password	>



Display Setting	
Trip reset	No
Unit	Imperial
Brightness	100%
SOC View	percent
Auto Off	5Min
AL Sensitivity	5
Set Voltage	36V
Password	>

English and Metric Unit Conversion Setting Screen

◆ **Backlight Brightness Setting**

Short press "UP" or "DOWN" to select "Brightness", short press "ON/OFF" to enter the setting, by short press "UP" or "DOWN", the backlight brightness range is "100%-75%-50%-30%-15%". Enter the setting, by short press "UP" or "DOWN", the backlight brightness range is "100%-75%-50%-30%-15%" 5 levels of brightness, short press "UP" or "DOWN", the backlight brightness range is "100%-75%-50%-30%-15%". The brightness range of backlight is "100%-75%-50%-30%-15%", 100% corresponds to the highest brightness, 15% corresponds to the lowest brightness; short press "ON/OFF" to save and exit to "Brightness". The default backlight brightness of the display is "100%".

Display Setting	
Trip reset	No
Unit	Metric
Brightness	100%
SOC View	percent
Auto Off	5Min
AL Sensitivity	5
Set Voltage	36V
Password	>



Display Setting	
Trip reset	No
Unit	Metric
Brightness	75%
SOC View	percent
Auto Off	5Min
AL Sensitivity	5
Set Voltage	36V
Password	>

Backlight brightness setting interface

◆ **Battery percentage and voltage display**

Short press "UP" or "DOWN" to select "SOC View", short press "ON/OFF" to enter the setting. "Enter the setting, short press "UP" or "DOWN" to switch to: "Voltage (Voltage Display)"; the default meter is "Percent", press "ON/OFF" to save and exit to "SOC View".

Display Setting	
Trip reset	No
Unit	Metric
Brightness	100%
SOC View	percent
Auto Off	5Min
AL Sensitivity	5
Set Voltage	36V
Password	>



Display Setting	
Trip reset	No
Unit	Metric
Brightness	100%
SOC View	Voltage
Auto Off	5Min
AL Sensitivity	5
Set Voltage	36V
Password	>

Power percentage/voltage display setting screen

◆ **Auto Power Off Time Setting**

"Auto Off" indicates the setting of automatic shutdown time. Short press "i" to enter the setting, by short press "UP" or "DOWN" to select the automatic shutdown time, the range is "OFF, 1-9 (Min)", short press "i" to save and exit to "Auto Off". The range is "OFF, 1-9 (Min)", short press "i" to save and exit to "Auto Off". The default auto off time of the meter is 5Min.

Display Setting	
Trip reset	No
Unit	Metric
Brightness	100%
SOC View	percent
Auto Off	5Min
AL Sensitivity	5
Set Voltage	36V
Password	>



Display Setting	
Trip reset	No
Unit	Metric
Brightness	100%
SOC View	percent
Auto Off	8Min
AL Sensitivity	5
Set Voltage	36V
Password	>

Auto Power Off Time Setting Screen

◆ **Light Sensor Sensitivity Setting**

"AL Sensitivity" indicates the sensitivity setting of light sensor. Short press "i" to enter the setting, and short press "UP" or "DOWN" to select the sensitivity value of the light sensor. The range is "5-4-3-3-2-1-OFF", press "i" to save and exit to "AL Sensitivity". The default sensitivity of the meter is 5.

Display Setting	
Trip reset	No
Unit	Metric
Brightness	100%
SOC View	percent
Auto Off	5Min
AL Sensitivity	5
Set Voltage	36V
Password	>



Display Setting	
Trip reset	No
Unit	Metric
Brightness	100%
SOC View	percent
Auto Off	5Min
AL Sensitivity	3
Set Voltage	36V
Password	>

Light Sense Sensitivity Setting Interface

◆ **Battery voltage setting**

Short press "UP" or "DOWN" to select "Set Voltage", the meter defaults to 36V

and cannot be changed.

Press and hold **"ON/OFF"** to return to the main screen or **"BACK"** to return to the main screen.

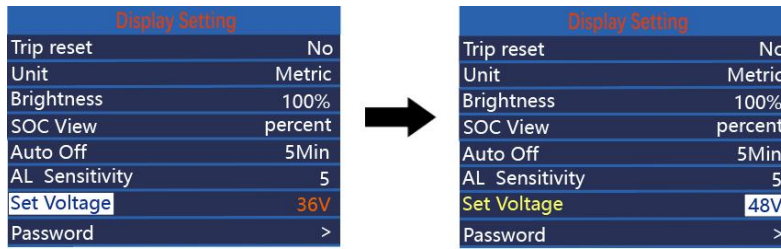

Battery voltage setting interface

◆ Power-on password setting

Short press **"UP"** or **"DOWN"** to select **"Password"**, short press **"ON/OFF"** to enter setting. Enter setting, select Start PassWord by short press **"UP"** or **"DOWN"**, short press **"ON/OFF"** to switch between **"PassWord"** and **"password"**. Short press **"ON/OFF"** to switch **"OFF"/"ON"**, the following is the specific switching method. There is no power-on password by default.

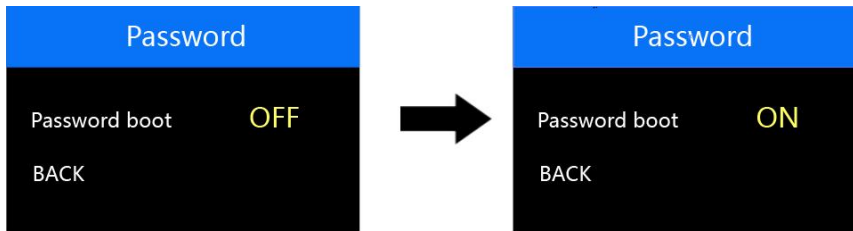

Power-on password setting screen

◆ Power-on password enable

In the **"PassWord boot"** interface, select **"ON"**, press **"ON/OFF"** to confirm, the interface prompts to enter the password, press **"UP"** or **"DOWN"** to increase/decrease the input value, press **"ON/OFF"** to shift the value, after the 4-digit password input, press **"ON/OFF"** to shift the value. **UP"** or **"DOWN"** key to add/subtract the input value, short press **"ON/OFF"** key to shift the value, after 4-digit password input, short press **"ON/OFF"**. **"ON/OFF"** to confirm; the interface prompts to enter the password again, after the two inputs are the same, the system prompts the password set successfully, if the two inputs are not the same, then you need to repeat the first step to enter a new password and then confirm that the password is set successfully, the 2S interface automatically jumps to the original setup interface.

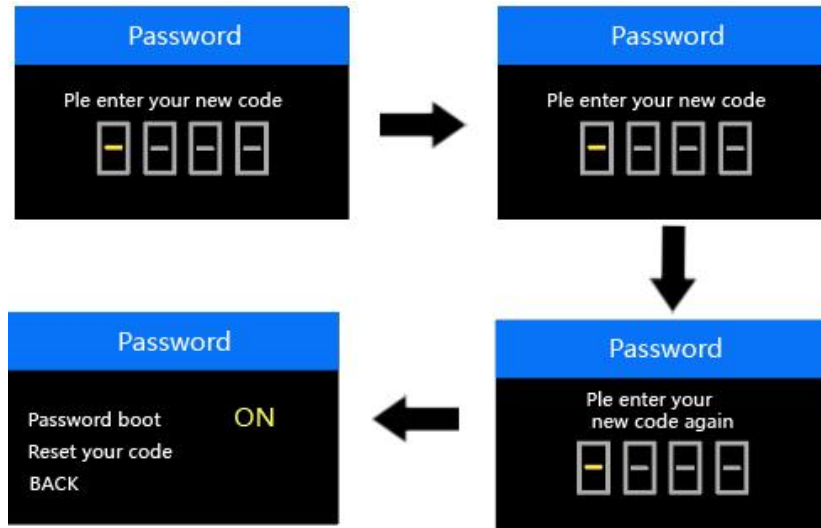

Password Enable Confirmation Screen

◆ **Power-on password change**

After opening the password, "Pass word" interface will add "Reset your code" option, short press "UP" or "DOWN" to select "Reset Password", short press "ON/OFF" again to make sure. Short press "UP" or "DOWN" to select "Reset Password", short press "ON/OFF" again to make sure, at this time, the interface prompts you to enter the current password, the password is entered correctly, the interface prompts you to enter the new password. The interface prompts you to input the new password after the password is input correctly, and the operation will be the same as the new password, after the password is modified successfully, the 2S interface will automatically jump to the original setting interface.

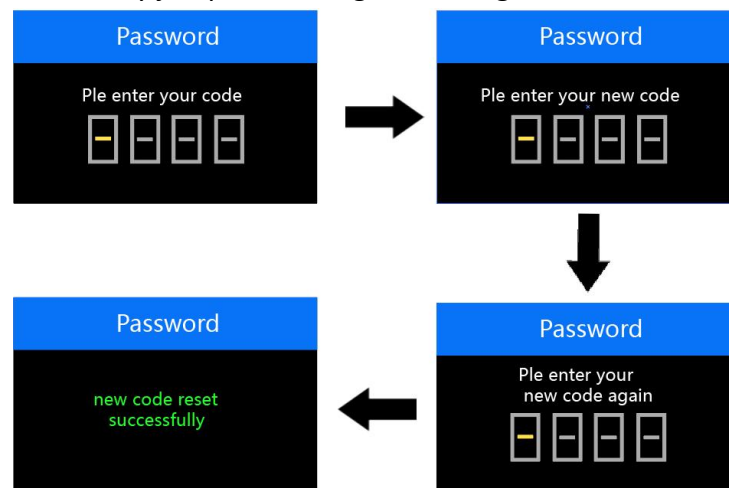

Password change screen

◆ **Disable Password**

After selecting "OFF" in the "PassWord" interface, press "ON/OFF" briefly to make sure, at this time, the interface prompts you to input the password, after the

password is correctly input, the interface prompts you that the password function is successfully turned off. After the password is correctly entered, the interface prompts that the password function is closed successfully, and the interface automatically jumps to the original setting interface after 2S.

Long press "ON/OFF" to exit to the main interface or "BACK" to exit to the setting interface, short press "ON/OFF" to select EXIT to return to the main interface.



●Advanced Setting

In the **DisPlay Setting** menu, select **EXIT**, press **ON/OFF** to return to the main interface, press **UP** or **DOWN** to select "**Advanced Setting**", press **ON/OFF** to enter the **Advanced Setting** menu. Select "**Advanced Setting**" by short press "**UP**" or "**DOWN**", then short press "**ON/OFF**" to enter **Advanced Settings** setting menu;

◆Max pas modes

Short press "**ON/OFF**" to confirm, short press "**UP**" or "**DOWN**" to switch gear "**0-3, 1-3, 0-5, 1-5, 0-7, 1-7, 0-9, 1-9**" **8 modes**, short press "**ON/OFF**" to save the setting, and return to the setting item selection interface. **5, 0-7, 1-7, 0-9, 1-9**" **8 modes**, short press "**ON/OFF**" to save the setting and return to the setting item selection interface.

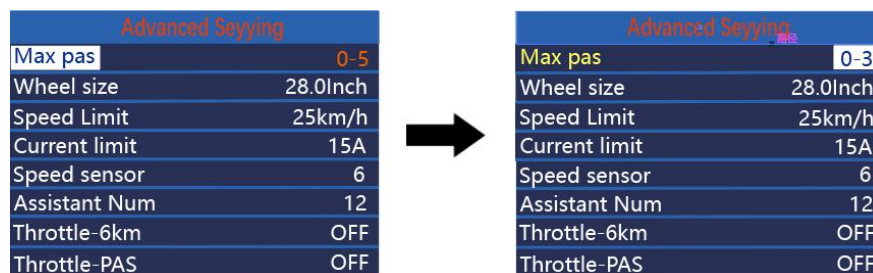

Gear setting interface

◆Wheel size

Short press "**UP**" or "**DOWN**" to select "**Wheel**", short press "**ON/OFF**". Enter the setting, short press "**UP**" or "**DOWN**" to switch the wheel diameter, the optional wheel diameter range is: "**18-29Inch**". Short press "**ON/OFF**" to save and exit to "**Wheel**".

Press and hold "**ON/OFF**" to return to the main screen or "**BACK**" to return to

the main screen.

Advanced Seeying	
Max pas	0-5
Wheel size	28.0Inch
Speed Limit	25km/h
Current limit	15A
Speed sensor	6
Assistant Num	12
Throttle-6km	OFF
Throttle-PAS	OFF



Advanced Seeying	
Max pas	0-5
Wheel size	26.0Inch
Speed Limit	25km/h
Current limit	15A
Speed sensor	6
Assistant Num	12
Throttle-6km	OFF
Throttle-PAS	OFF

Wheel diameter setting interface

◆ Speed Limit

Short press "UP" or "DOWN" to select "Speed Limit" to see the speed limit value, default 25km/h, not adjustable. Press and hold "ON/OFF" to return to the main interface or "BACK" to return to the main interface.

Advanced Seeying	
Max pas	0-5
Wheel size	28.0Inch
Speed Limit	25km/h
Current limit	15A
Speed sensor	6
Assistant Num	12
Throttle-6km	OFF
Throttle-PAS	OFF



Advanced Seeying	
Max pas	0-5
Wheel size	28.0Inch
Speed Limit	25km/h
Current limit	15A
Speed sensor	6
Assistant Num	12
Throttle-6km	OFF
Throttle-PAS	OFF

Speed limit interface

◆ current limit

Short press "UP" or "DOWN" to select "Current Limit" to view the current limit value, the default current limit value is "15A". The default current limit value is "15A", which is not adjustable. Press and hold "ON/OFF" to return to the main interface or "BACK" to return to the main interface.

Advanced Seeying	
Max pas	0-5
Wheel size	28.0Inch
Speed Limit	25km/h
Current limit	15A
Speed sensor	6
Assistant Num	12
Throttle-6km	OFF
Throttle-PAS	OFF



Advanced Seeying	
Max pas	0-5
Wheel size	28.0Inch
Speed Limit	25km/h
Current limit	15A
Speed sensor	6
Assistant Num	12
Throttle-6km	OFF
Throttle-PAS	OFF

Current limit interface

◆ Speed Sensor

Short press "UP" or "DOWN" to select "Speed Sensor" to check the number of magnets of speed sensor, the default value is "6". The default value is "6" which is not adjustable. Press and hold "ON/OFF" to exit to the main interface or "BACK" → to exit to the main interface.

Advanced Setting	
Max pas	0-5
Wheel size	28.0Inch
Speed Limit	25km/h
Current limit	15A
Speed sensor	6
Assistant Num	12
Throttle-6km	OFF
Throttle-PAS	OFF



Advanced Setting	
Max pas	0-5
Wheel size	28.0Inch
Speed Limit	25km/h
Current limit	15A
Speed sensor	6
Assistant Num	12
Throttle-6km	OFF
Throttle-PAS	OFF

Speed Sensor

◆ Assistant Num

Short press "UP" or "DOWN" to select "Assistant Num" to check the number of assistant magnets, the default value is "12", not adjustable. The default value is "12", not adjustable. Press and hold "ON/OFF" to return to the main interface or "BACK" to return to the main interface.

Advanced Setting	
Max pas	0-5
Wheel size	28.0Inch
Speed Limit	25km/h
Current limit	15A
Speed sensor	6
Assistant Num	12
Throttle-6km	OFF
Throttle-PAS	OFF



Advanced Setting	
Max pas	0-5
Wheel size	28.0Inch
Speed Limit	25km/h
Current limit	15A
Speed sensor	6
Assistant Num	12
Throttle-6km	OFF
Throttle-PAS	OFF

Assistant Num

◆ Throttle-6km

"Throttle-6km" is OFF by default and non-adjustable. long press "ON/OFF" to exit to the main interface or exit to "BACK" to set interface. Setting interface.

Advanced Setting	
Max pas	0-5
Wheel size	28.0Inch
Speed Limit	25km/h
Current limit	15A
Speed sensor	6
Assistant Num	12
Throttle-6km	OFF
Throttle-PAS	OFF

Throttle - 6km

◆ Throttle-PAS

"Throttle-PAS" is OFF by default. Non-adjustable.

long press "ON/OFF" to exit to main interface or "BACK" to exit to setting interface.

Advanced Setting	
Max pas	0-5
Wheel size	28.0Inch
Speed Limit	25km/h
Current limit	15A
Speed sensor	6
Assistant Num	12
Throttle-6km	OFF
Throttle-PAS	OFF

Throttle-PAS

◆ Language Selection

Language" stands for language setting, short press "UP" or "DOWN" to select

"Czech", "French", "German", "English". Short press "UP" or "DOWN" to select "Czech", "French", "German", "English", short press "ON/OFF" to confirm, the default is English, long press "ON/OFF" to confirm, long press "ON/OFF" to confirm, the default is English. "Long press "ON/OFF" to exit to the main interface or "BACK" to exit to the setting interface.

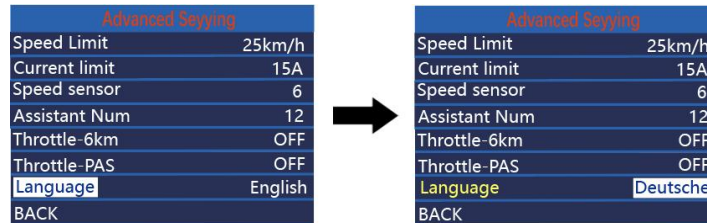

Language Selection Setting Screen

■ The display automatically exits the setup state if no operation is performed within 1 minute.

◆ Connector pinout.

Julet 5 pin male, Model No. JL-F39-Z508JG

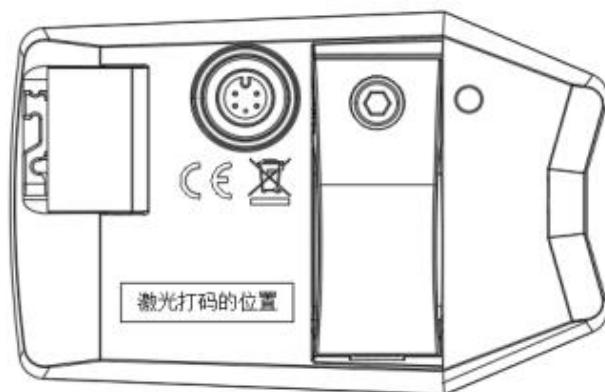

Pinout table

serial number	names	functionality
1	VCC	display Power Cord
2	KP	Power control cable for controller
3	GND	GND
4	RX	Data receiving line of the display
5	TX	Data transmission line of the display

Exhibit 1: Error Code Definition Table

error code	define
21	current fault
22	Throttle fault
23	Motor phase is absent
24	Motor Hall signal abnormality
25	Brake abnormality
30	Communication fault between display and controller

Quality Commitment and Warranty Coverage

I. Warranty information:

1、Where the normal use of the product itself due to quality problems caused by the failure, in the warranty period the company will be responsible for giving limited warranty.

2、The warranty period of the product is within 24 months from the meter's factory.

II. The following are not covered by the warranty

1. Shell is opened
- 2、 Connector is damaged
- 3、 Meter factory, shell scratches or shell damage
- 4、 Meter lead wire scratched or broken
5. Failure or damage due to irresistible (e.g., fire, earthquake, etc.) or natural disasters (e.g., lightning strikes, etc.)
6. Product out of warranty

Warnings

Pay attention to the safety of use in the process, do not plug and unplug the meter under power.

- ◆ Avoid bumping the meter as much as possible.
- ◆ Regarding the background parameter settings of the meter, please do not change them arbitrarily, otherwise normal riding cannot be guaranteed.
- ◆ When the meter is not working properly it should be sent for repair as soon as possible.

Maintenance

Regular maintenance:

- maintain all components of the electric bicycle clean
- use only the recommended and tested cleaning materials
- regularly lubricate the chain with suitable oils
- in winter, clean the electric bicycle after each ride and pay increased attention to removing salt from battery contacts and other connectors
- while handling the electric bicycle, make sure the cables of the electric system are not damaged. Damaged cables pose a risk of electric shock
- regularly check all connections for correct tightening and brakes for correct function. Check also individual parts of the electric bicycle for damage. For example: cracks on the frame, fork, handlebars, stem, damage to cables, damage to battery pack, etc.

Battery transport:

Battery transport is subject to the requirements of regulations on dangerous goods. Private users may transport undamaged batteries on roads without having to conform to other conditions.

In case of transport by commercial users or by third parties it is necessary to comply with special packaging and marking requirements (e.g. ADR regulations)

Batteries should only be sent if the battery pack is undamaged. Plug loose contacts and pack the battery to prevent its movement in the packaging. Notify the forwarding service that the transport concerns dangerous goods.

Battery storage:

Store the battery in a dry and well-ventilated place, out of reach of direct sunlight and other heat sources. In case of cold storage it is necessary to let the battery warm up to normal room temperature (20°C) before putting into operation.

Never leave the battery fully discharged. It could result in its permanent damage. For long-term storage keep the battery fully charged. However, do not store it while permanently connected to the charger or installed in the electric bicycle.

Li-Ion batteries are fully recyclable. After expiry of the battery life you can return it at any collection point or your dealer.

If you use an e-bike in hard conditions (long-term use of the maximum assistance), for longer ride at higher temperatures (30 ° C or above), in direct sunlight or when the battery is partially discharged and a combination of these situations is it possible that bike will automatically switch off. This is a fuse protecting the control unit against burning. We recommend stop the ride and let the bike (control unit) cool down little bit. This is not a defect.

Possible problems and their solutions

In case of system failure perform its diagnostics or contact your dealer.

The control LCD display is not on:

- always make sure the battery is charged
- check whether the battery is inserted correctly, whether the battery switch is on
- check the connections of the control unit and the display

The motor does not start when the walk assistance button is pressed

- check the connection of the motor cable (at the motor and the control unit)
- check the connections of the control unit and the display

The motor does not start when rotating the pedal cranks (pedalling)

- check the connection of the pedalling sensor to the control unit
- check the distance between the pedalling sensor and the magnet disk (max. 4 mm)
- check whether the disk is firmly attached to the central axle and does not spin freely
- in case of use of compact-type pedalling sensor

Warning

When there is a problem with the electric bicycle, it can show error messages. LCD display will show the icon and an error code will be displayed on the speed display. Error codes are marked from 01 E~FF E; see their meaning in the table below.

Error code	Description	Solution
6	Low battery voltage	Check battery voltage
7	High voltage protection	Check battery voltage
8	Hall probe error	Check motor
9	Three-phase supply error	Check motor
11	Overheating controller sensor	Check controller
12	Overvoltage controller sensor	Check controller
13	Overheated battery	Check battery
21	Speed sensor error	Check the position of the sensor
22	BMS communication error	Change battery
30	Communication error	Check connectors

Assembly and disassembly of the wheel with the engine

For transportation and maintenance (replacing the tire tube) it may sometimes be necessary to disassemble the wheel with the engine.

First, pull lightly to disconnect the engine connector (about 20 cm from the engine entry).

Then loosen the brake (if it is used) and change the gear to the smallest wheel.

Remove the rubber covers from the wheel nuts.

Loosen the engine nut using a spanner size 18 and remove the wheel from the frame.

For assembly, reverse the order of these steps.

To connect the connector properly, the arrows on the connector (1) must face each other.

Switch the drive unit on and test it.

During wheel assembly, pay attention to the proper position of the central axis of the wheel nave facing down. The cable must enter the engine from below. Otherwise, water could get into the engine on the cable and the engine could be damaged.

Electric set warranty

Complaint procedure:

Submit any complaints concerning the electric set or the battery to your dealer.

When filing a complaint, submit a proof of purchase and a warranty certificate with the registered serial number of the battery and indicate the reason for the complaint and a description of the defect.

Warranty conditions:

24 months for electric bicycle components – applies to manufacturing and material defects beyond normal wear and tear caused by use.

12 months for battery life – the nominal battery capacity does not drop below 70% of the total capacity over 12 months from the sale of the electric bicycle.

Warranty conditions:

The electric set must be used exclusively for the purposes it is intended for.

The electric set must be used, stored and maintained in accordance with these Operating Instructions.

A warranty claim shall expire:

If it is found out that the damage to the product is due to the user's fault (accident, inexpert handling beyond the framework of these Operating Instructions, tampering with the structure of the electric bicycle or connection of the electric system, improper storage, etc.).

Expiry of the warranty period.

The warranty only applies to the first owner

Warning

If you do not understand any of the points in these Operating Instructions, please contact the dealer for explanation. Please read the whole manual!

Do not lend the e-bike to persons not briefed in its use and operation. Complaints resulting from improper handling will not be accepted.

The LF Energy electric bicycle is not intended for use by children under 15 years of age. Likewise, the electric bicycle cannot be used by persons unable to pedal or handle it independently. The manufacturer is not to be held responsible for any potential injuries or damage to the bicycle!

Ideal weather conditions for using an electric bicycle are dry days, when the outdoor temperature is above 10°C. When used at lower temperatures, the battery discharges faster due to physical phenomena. Using the electric bicycle at temperatures below 0°C is not recommended.

Do not expose the bicycle to direct sunlight as it is fitted with a protective temperature sensor for the electric motor.

Never submerge the battery, the charger and other electric components in water or another liquid.

Never wash the electric bicycle in a pressure washer (WAP) and always remove the battery before washing

It is forbidden to tamper with the connections of the electric motor, the control unit and the battery. Violating this section may result in the warranty not being acknowledged or in irreversible damage to the electric bicycle.

DO NOT USE chargers and components other than the ones included with the electric bicycle.

We cannot be held responsible for damage caused by use of other non-approved goods

LEADER FOX



Enjoy many pleasant and safe kilometres on your new electric bicycle.

Your Leader Fox Team



**Czech brand of electric bicycles.
BOHEMIA BIKE**

Address

Pujmanové 1753/10 a
140 00 Praha 4 – Nusle

Development, design and manufacturing

Okružní 697
České Budějovice 37001

Phone: 388 314 885
Email: info@leaderfox.cz

