

# **LEADER FOX**



## Electric Bicycle Operating Instructions

Under the law, the dealer is obliged to attach the LEADER FOX Electric Bicycle Operating Instructions to every product



**E – BIKE** POWER RIDE

**Benton**



# Introduction

---

Dear users,

Please read carefully all the information regarding your E-LF product to ensure optimal functioning of your e-bike. The following text containing a comprehensive description will provide you with information on all aspects and details (including installation, setting up and general use of the display) regarding the use of our display. This instruction document will also help you solve potential problems and failures.

## What is an electric bicycle?

---

Electric bicycle is a conventional bicycle with an electric drive added to assist the rider. The motor function is actuated by pedalling, which is scanned by a special sensor installed in the pedal hub. Therefore, you have to keep pedalling on an e-bike, the motor is there only to help you. You can set an electric bicycle in motion also using a control button or an accelerator but only up to the maximum permitted speed of 6 KMPH (e.g. for walk assistance). The maximum speed of an e-bike with motor assistance is 25 KMPH, with a 10% tolerance (when this speed limit is reached, the motor switches off and you need to pedal just like with a regular bicycle). When your battery runs out of power or your motor is off, you can ride your electric bicycle as a conventional bike, without any resistance at all.

From the point of view of the Road Traffic Act, an electric bicycle whose features conform to European standard EN 15194-1 is regarded as a regular bicycle, i.e. you can ride on bike trails, do not need a driver's license and a helmet is mandatory only up to 18 years of age.

## Description



## Factors influencing the electric bicycle range

- 1. Rolling resistance of the tyres.** Leader Fox e-bikes are fitted with tyres with low rolling resistance and increased resistance to puncture. It is also important that the tyres are inflated properly. Therefore, if the tyres of your electric bicycle are underinflated, the range will decrease.
- 2. Weight of the electric bicycle.** The lower weight of the electric bicycle, the greater the range.
- 3. Battery status.** It depends on whether the battery was fully charged before your trip. It is also to be expected that the higher the number of discharge cycles the battery has undergone, the smaller capacity it has.
- 4. Profile and surface of the track.** The higher the elevation difference and the steeper hills you negotiate and the worse surface, the shorter the range.
- 5. Riding mode.** It depends on which of the three riding modes you have set.
- 6. Continuity of riding.** The more braking and acceleration, the shorter the range.
- 7. Air resistance.** For example, it depends on whether we ride a bicycle with low frame and sitting upright or whether we ride sporty bicycle with seat set to the same height as the handlebars.
- 8. Wind strength.** The stronger the wind we have back, the longer the range and vice versa.
- 9. Weight of the rider and load.** The greater the weight, the shorter the range.
- 10. External temperature.** The lower the temperature, the less battery capacity can be used while riding.

# Electric set

## M510

The system uses monitoring of torque, monitoring of speed of the pedal assist system and monitoring of real speed of wheels.

The system uses a dual protection feedback for measuring the speed signal to ensure safety and reliability of the system.

It has high starting torque, maximum torque of over 95 Nm, suitable especially for riding uphill.

It is highly efficient with low power consumption, long range, low noise levels, and smooth operation.

### Description and scope of operation:

The motor unit works properly under the following operating conditions:

Temperature range - 20 + 55°C

Relative humidity - 15 – 95% RH

Maximum torque -  $\geq 95$

Weight - 3Kg

Noise - <55 dB

Dustproof/ waterproof - IP66

Certified - CE ROHS/ EN14766/ EN114764/ REACH

### Description of the power unit is placed on the cover and shows the following information:

MM G522.250 15 033 F5 S329 0001

MM – Mid motor

G520 – Engine model

250 – Rated engine power

15 – Number of winding turns

033 – Connection combination sort

F5 – Measurement and control equipment number

S329 – Date of manufacture, indicating it is manufactured on March 29, 2018

0001 – Production serial number, ranging from 0000 to 9999, 0001 is the production serial number of the first motor

**Dimensions of the power unit:**

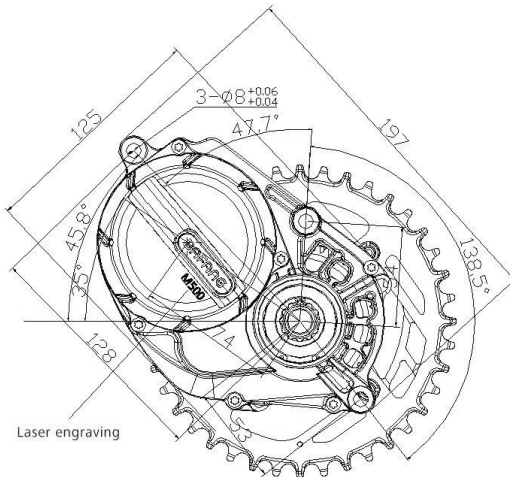
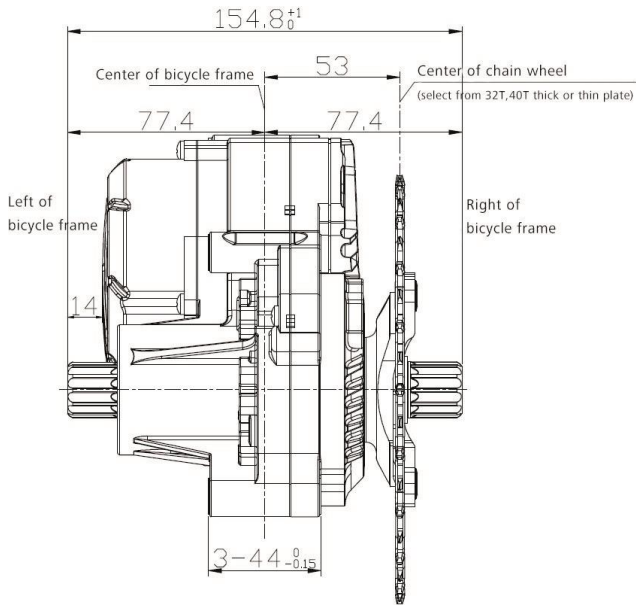

# Safety instruction

## Battery:

- Do not throw the battery into fire.
- Do not throw the battery into water.
- Do not use the battery for other appliances. It has been made specifically for this model.
- Do not dismantle or modify the battery.
- Do not connect the positive and negative poles of the battery.

## Charger:

- Do not dismantle or modify the charger.
- Do not use the charger for other appliances. It has been made specifically for this model.
- Do not throw the charger into fire or water.
- Do not touch the charger with wet hands.
- Keep the charger from animals or children.
- Do not cover the charger.
- Do not use the charger if it is broken.

## Charging set



# Battery

## **Battery charging and maintenance:**

Charge the battery in a dry environment to avoid short-circuit damage.

Charge the battery to at least 60% of the capacity once every 3 months even when the bicycle is not used.

Do not cover the battery or the charger.

Do not leave the battery constantly connected to the power source.

Do not use the battery for other appliances. It has been made specifically for this model.

Do not disassemble or modify the battery pack.

Do not throw the battery into fire or expose it to extreme temperatures.

Recharging time from zero to 100% is 1-7 hours.

## **Drive warranty:**

The warranty applies to those drive parts that are not sensitive to improper handling (pack, electronics, charger, etc.); such parts are covered by a 24-month warranty.

The warranty does not apply to chemical parts of the battery and to capacity reduction due to normal use (39% after the expiry of two years); those parts are covered by a 12-month warranty.

## **Charging:**

The battery is the most expensive part of an electric bicycle; therefore, pay increased attention during handling, charging and storage. The battery is sensitive to precise charging. Therefore, it is necessary to charge Li-Ion rechargeable batteries using only a charger supplied by us. Connect the charger to 220-240 V power outlet. 5A protected circuit is sufficient. The charger will automatically suspend charging when full capacity of all cells is reached.

We recommend discharging the battery in full after each ride to ensure that your battery will be up to its full capacity for your next ride. Charging the battery may last 1 to 5 hours depending on the condition of the battery cells. Charge it exclusively in covered dry areas (moisture and dripping water can damage the charger) at a temperature of 5 to 40°C.

The charging process is indicated by a red glowing LED. It will turn green when the battery is charged and the charging process is complete. The battery contains a charge-monitoring indicator (when the charge indicator button is pressed, the light indicator will come on). Always switch off the battery when finished riding the bike.

## **Normal battery behaviour:**

If the motor stops running smoothly and switches to intermittent operation, it could be a sign of low battery capacity. In that case switch off the electric drive system and continue without motor assistance, as if riding a conventional bicycle.

Battery warming is normal and does not indicate any defect. The battery is protected by a temperature sensor and switches off automatically in case of excessive overheating. Wait until the battery cools down to its normal operating temperature and then ride on.

If you feel your total battery capacity has dropped, it could be caused by charging or operation in suboptimal climatic conditions. Carry out 3 full charging cycles. Fully discharge the battery while riding and then charge to its full capacity at room temperature.

If the charge indicator shows that the battery is discharged, there is still a minimum voltage level in it which protects it against damage but is not enough to power the electric bicycle. Recharge the battery as soon as possible. Never leave the battery fully discharged, it could result in its damage.

In the case, that the battery will be turned on more than 30 min and bike will not be used, the battery will be automatically switched off.

**Proper care of the battery prolongs its life.**



## LCD display





**KEY-DISP**

The eBike Display  
**Users Manual**

**KD686**

---

## Contents

Product name and model .....	1
Specification .....	1
Appearance and dimension .....	1
Function summary .....	2
Function layout .....	2
Button definition .....	3
General operation .....	3
◆ Switch the E-bike system ON/OFF .....	3
◆ Display interface .....	3
◆ Switch the push-assist mode ON/OFF .....	4
◆ Light sensor function & display backlight ON/OFF .....	4
◆ Assist level .....	4
◆ Battery indicator .....	5
◆ Motor power indicator .....	5
◆ Error code indication .....	5
Settings .....	6
◆ Trip Reset .....	6
◆ Toggle Unit .....	6
◆ Wheel .....	7
◆ Speed limit .....	7
◆ Set voltage .....	8
◆ SOC view .....	8
◆ AL sensitivity .....	9
◆ Assist level Settings .....	9
◆ Current limit .....	10
◆ Assistant Num .....	10
◆ Speed sensor .....	11
◆ Slow start .....	11
◆ LCD luminance .....	12
◆ Factory settings .....	12
◆ Password Set .....	12
Password enable .....	13
Password change .....	14

Password disable .....	14
◆ Exit Settings .....	14
Display Connection Layout .....	15
Attached list 1: error code definition .....	15
Attached list 2: PAS level ratio defaults .....	16
Quality assurance and warranty scope .....	16
Warnings .....	16

## Product model

E-bike Intelligent color display  
Model: KD686

## Specifications

- 2.0 " IPS TFT
- 24V/36V/48V/52V/60V/72V Power Supply
- Rated working current :22mA
- Off-state leakage current: <math><1\mu A</math>
- Operating temperature:  $-10^{\circ}\text{C} \sim 60^{\circ}\text{C}$
- Storage temperature:  $-20^{\circ}\text{C} \sim 70^{\circ}\text{C}$

## Appearance and dimension

Product appearance and dimensional drawing (unit: mm)

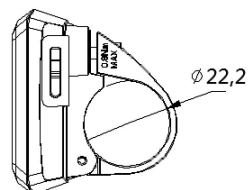
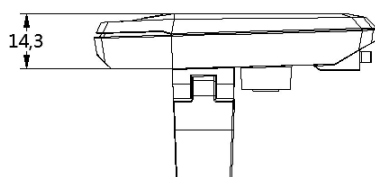
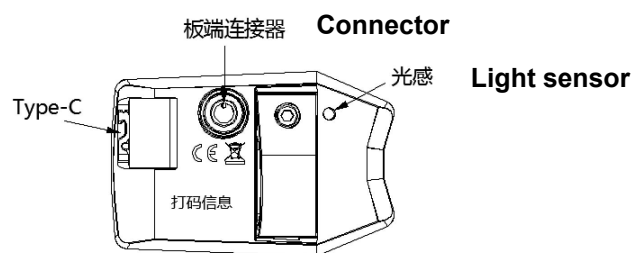
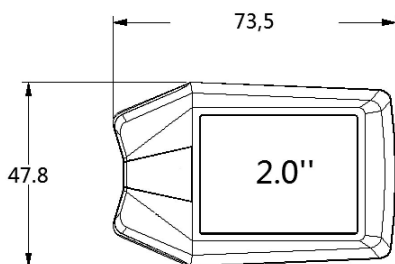

## Function Summary

KD686 has many functions to meet the Users' needs. The indicating contents are as follows:

- Battery indicator: voltage value or battery percentage
- Intelligent indication of TRIP, ODO, Current speed, MAX. speed and AVG. Speed, and TRIP time
- Motor power
- assist-level selection and indication
- The push-assist control and indication
- Backlight On/Off and headlight icon indication
- Error code indication
- Type-C port
- Light sensor
- Various Parameters Settings (e.g., Trip clearance, Back-light, Unit toggle, wheel size, speed-limited, battery level bar, assist level, controller limited current, power-on password settings, etc.)
- Recover Default Settings
- Bluetooth function( **optional**)

## Function layout:

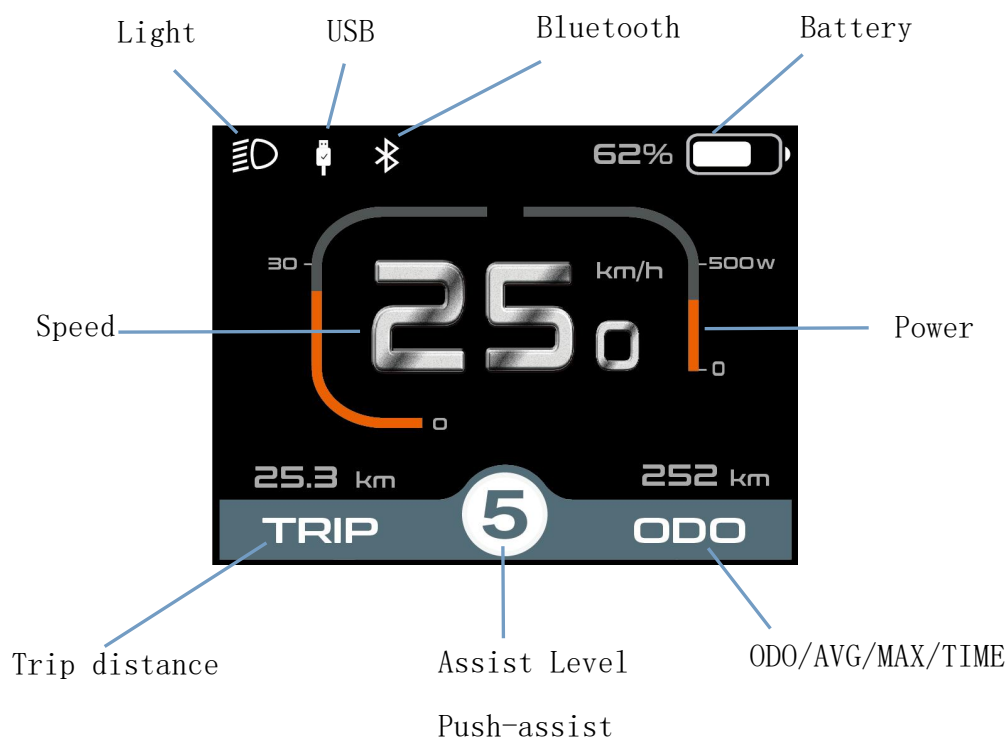

## Button definition

3 buttons on KD686 display, on/off, +/light, -/push-assist

## General Operation

### ◆ Switching the E-bike System On/Off

Hold the **on/off** button to switch on E-bike system and provide the power supply for the controller. When display is on, hold the **on/off** button to switch off the bike system. The E-bike system no longer uses the battery power. When the E-bike system is switched off, the leakage current is less than 1  $\mu$ A.

■ When E-bike is not in use for 5 minutes, the E-bike system will switch off automatically.

### ◆ Display Interface

After switching on the E-bike system, the display will show Current Speed and Trip Distance, ODO, Power, Battery level, and Assist level.

Press the “**on/off**” button to check: **ODO (km)**--> **Max Speed (km/h)**--> **AVG speed (km/h)**--> **Trip time (min)**

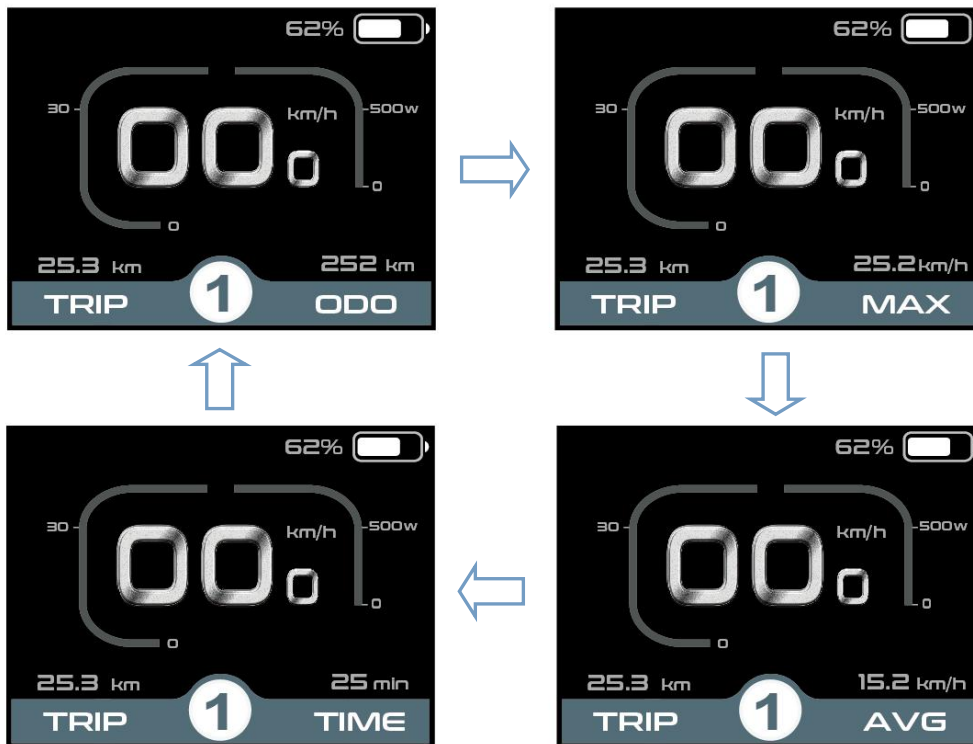

Display interface cycle

### ◆Switching Push-assist Mode On/Off

To activate the push-assist function, keep holding “-” button. After 2 seconds , E-bike is activated to go at a uniform speed of 6 Km/h while the screen displays  .

The push-assist function is switched off as soon as you release the “-” button. The E-bike system stops the power output immediately and get backs to the status before the push-assist is activated.



Push-assist Mode

### ◆light sensor function and switching the lighting ON/OFF manually

Display has a light sensor which automatically switches ON/OFF the lights. When there's a lack of light or riders drive ebike at night, display backlight is on and in the meantime, display sends command to controller to turn on the bike headlight. When the light condition is good, display back-light and bike light will be off. However, when the user **manually** holds the + button for over 2 seconds, display will be turning on/off the headlight and the light sensor function is not in effect any more.

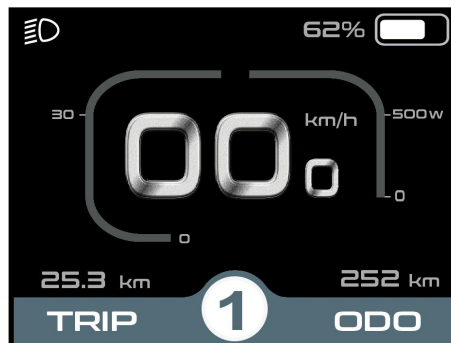

Lighting on/off

### ◆Assist Level

Press "+" or "-" button to switch the E-bike system assist level, change the motor output power, The default assist level ranges from level “0”to level “5”, The output power is zero on Level “0”. Level “1” is the minimum power. Level “5” is the maximum power. The default value is level “1”.





Assist Level Interface

◆ **Battery Indicator**

Battery voltage is switchable between 36 and 48 volts. The default voltage is 36V. and the voltage bar values for 36v are 31.5V-34.5V-35.6V-37.4V-39.2V

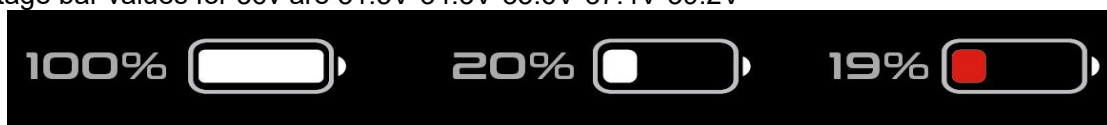

Battery Indicator interface

◆ **Motor Power Indicator**

The power of the motor is shown below

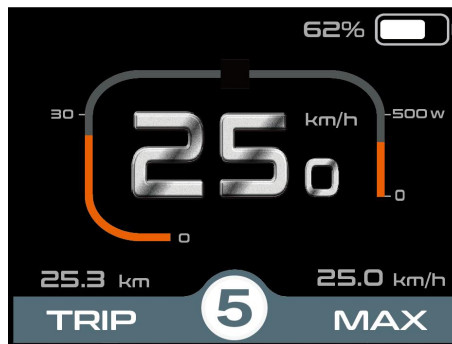

Motor Power Indication Interface

◆ **Error Code Indication**

The components of the E-bike system are continuously and automatically monitored. When an error is detected, the respective error code is indicated in text indication area.

Here is the detail message of the error code in Attached list 1.



Error Code Indication

■ when an error code appears, please repair the fault. Or you will not be able to ride the bike normally.

## Settings( Display Setting)

Press the power button to switch on the display. To access settings page, hold both the “+” and “-” button for 2s.

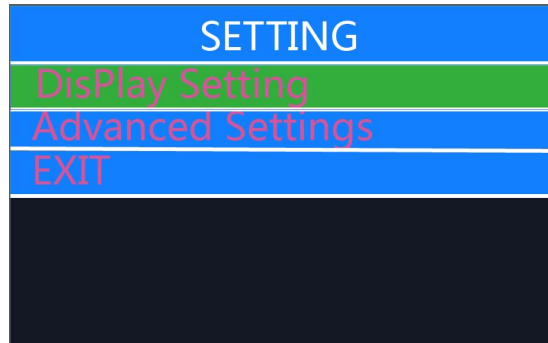

Settings Interface.

**Note:** all the settings must be done to a parked bike with no spe

## ● DisPlay Setting

### ◆ Trip Reset

**Trip Reset** represents trip distance clearance setting. \*And at the same time, **Max. Speed, AVG Speed, Trip time** will be cleared as well. Press the “+” button or the “-” button to select Yes or No. To confirm and store a changed setting, press the “on/off” button. When display or E-bike system is off, the above data will not be cleared automatically. The default setting is “**TRIP Rest-NO**”

Or Hold “on/off” button to return to home page or press **BACK** to return home page.

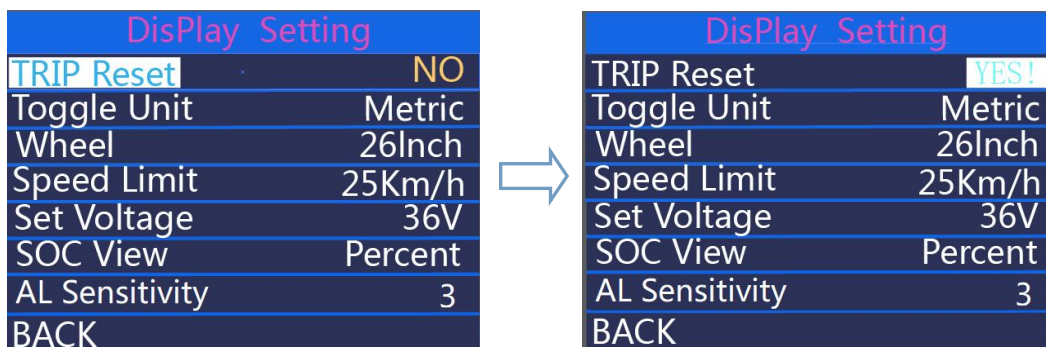

Trip reset interface

### ◆ Toggle unit

**Toggle Unit** represents change unit between **Metric** and **Imperial** . The default is

“Metric”. To toggle unit, press the “+” button or the “-” button to choose the desired setting item, and then press the “on/off” button to save and return back to “Toggle Unit”

Hold “on/off” button to return to home page or press **BACK** to return home page.

DisPlay Setting	
TRIP Reset	NO
Toggle Unit	Metric
Wheel	26Inch
Speed Limit	25Km/h
Set Voltage	36V
SOC View	Percent
AL Sensitivity	3
BACK	

DisPlay Setting	
TRIP Reset	NO
Toggle Unit	Imperial
Wheel	26Inch
Speed Limit	25Km/h
Set Voltage	36V
SOC View	Percent
AL Sensitivity	3
BACK	

Toggle unit interface

◆ **Wheel represents wheel diameter settings.**

Press the “+” or the “-” button to increase or decrease until the desired value is displayed. To store a changed setting, press the “on/off” to save and return back to **Wheel**.

hold “on/off” button to return to home page or press **BACK** to return to home page.

DisPlay Setting	
TRIP Reset	NO
Toggle Unit	Metric
Wheel	26Inch
Speed Limit	25Km/h
Set Voltage	36V
SOC View	Percent
AL Sensitivity	3
BACK	

DisPlay Setting	
TRIP Reset	NO
Toggle Unit	Metric
Wheel	28Inch
Speed Limit	25Km/h
Set Voltage	36V
SOC View	Percent
AL Sensitivity	3
BACK	

Wheel setting interface

◆ **Speed limit**

Press +/- to select “Speed limit” and press **on/off** to enter the settings. Press +/- to choose the speed limit value from 12-40 km/h. press **on/off** to save and return back to “ **Speed limit**” .

hold “on/off” button to return to home page or press **BACK** to return to home page.

DisPlay Setting	
TRIP Reset	NO
Toggle Unit	Metric
Wheel	26Inch
Speed Limit	25Km/h
Set Voltage	36V
SOC View	Percent
AL Sensitivity	3
BACK	

DisPlay Setting	
TRIP Reset	NO
Toggle Unit	Metric
Wheel	26Inch
Speed Limit	20Km/h
Set Voltage	36V
SOC View	Percent
AL Sensitivity	3
BACK	

Speed limit interface

◆ **Set Voltage represents voltage settings.**

Press **on/off** button to set the voltage power bar values. 5 bar values are to be set one by one. For example (36V mode), the first bar voltage value by default is 31.5V and press **+/-** button to change this value and press **on/off** to confirm and access the next bar value setting. After 5 values are set, press **on/off** to confirm.

hold “**on/off**” button to return to home page or press **BACK** to return to home page.

DisPlay Setting	
TRIP Reset	NO
Toggle Unit	Metric
Wheel	26Inch
Speed Limit	25Km/h
Set Voltage	36V
SOC View	Percent
AL Sensitivity	3
BACK	



DisPlay Setting	
TRIP Reset	NO
Toggle Unit	Metric
Wheel	26Inch
Speed Limit	25Km/h
Set Voltage	48V
SOC View	Percent
AL Sensitivity	3
BACK	

Voltage 36V/48V changeable

DisPlay Setting	
TRIP Reset	NO
Toggle Unit	Metric
Wheel	26Inch
1 - 31.5V	25Km/h
2 - 34.5V	36V
3 - 35.6V	Percent
4 - 37.4V	3
5 - 39.6V	



DisPlay Setting	
TRIP Reset	NO
Toggle Unit	Metric
Wheel	26Inch
1 - 31.9V	25Km/h
2 - 34.5V	36V
3 - 35.6V	Percent
4 - 37.4V	3
5 - 39.6V	

Segmented voltage values

◆ **SOC view**

Press **+/-** to select SOC View and press **on/off** button to enter the setting. Press **+/-** to change between Voltage values and percentage of Battery. The default view method is percentage. Press **on/off** to store the data and exit SOC view settings.

Hold “**on/off**” button to return to home page or press **BACK** to return to home page.

DisPlay Setting	
TRIP Reset	NO
Toggle Unit	Metric
Wheel	26Inch
Speed Limit	25Km/h
Set Voltage	36V
SOC View	Percent
AL Sensitivity	3
BACK	



DisPlay Setting	
TRIP Reset	NO
Toggle Unit	Metric
Wheel	26Inch
Speed Limit	25Km/h
Set Voltage	36V
SOC View	Voltage
AL Sensitivity	3
BACK	

SOC view interface

◆ **AL Sensitivity**

**AL Sensitivity** means light sensor sensitivity. Press +/- button to change the sensitivity value, the optional value is 01 to 05. press **on/off** button to confirm and store a changed setting.

Hold “**on/off**” button to return to home page or press **BACK** to return to home pag

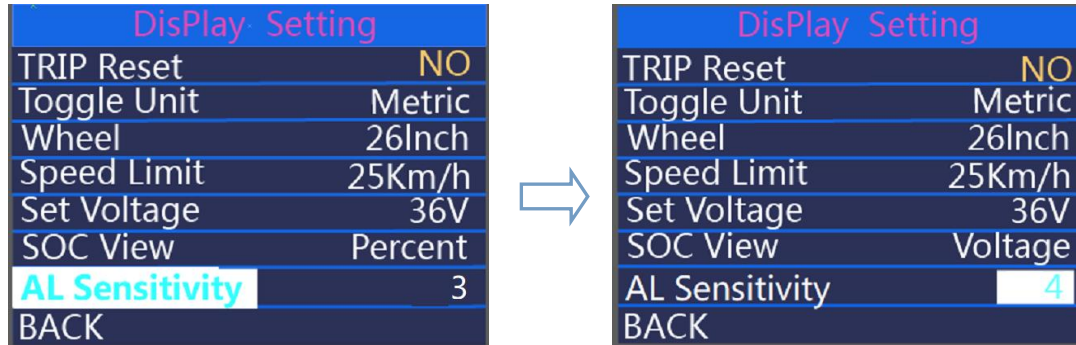

AL Sensitivity interface

● **Advanced Settings**

When **DisPlay Setting** is done, choose **BACK** and press **ON/OFF** button to return to home page. And press +/- button to move to Advanced Settings

◆ **Assist Level Settings**

**Power Set** represents assist level settings.

**Assist Level Modes**

3 assist level modes for your choice: 0-3, 0-5, 0-9. The default mode is 0-5. To change the mode of assist level, press the “+” or the “-” button to choose the desired mode and press the “ **on/off** ” button to confirm and access PAS ratio settings automatically.



Assist level mode interface

**Assist level Ratio Settings**

To change the assist level ratio, press the "+" button or "-" button to choose the desired percent



value, and press the " on/off " button to confirm and move to the next assist level ratio settings. After all assist level ratios were set, \*Please refer to assist level ratio defaults in **Attached list 2**.

hold **on/off** button to confirm and store the settings.

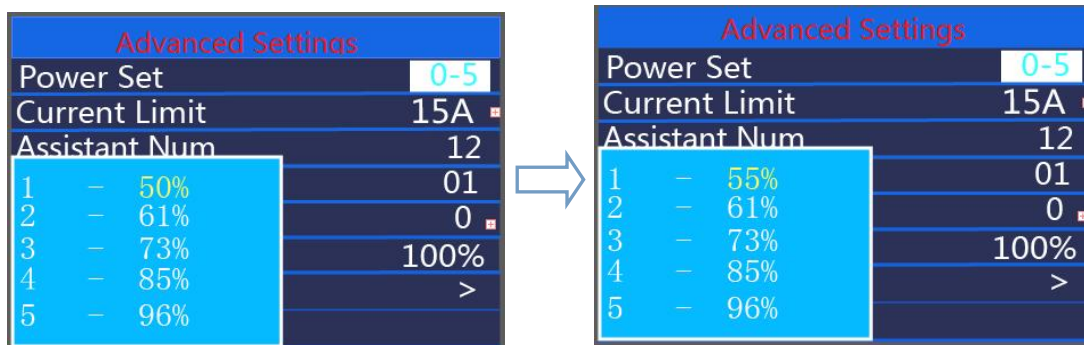

Assist level ratio settings

#### ◆ Current limit

**Current Limit** represents controller current limit settings. To change basic settings, press the "+" or the "-" button to increase or decrease the value. To store a changed setting, press the "on/off" button. Or

Hold **on/off** button to return to the home page or press **BACK** to return to home page.

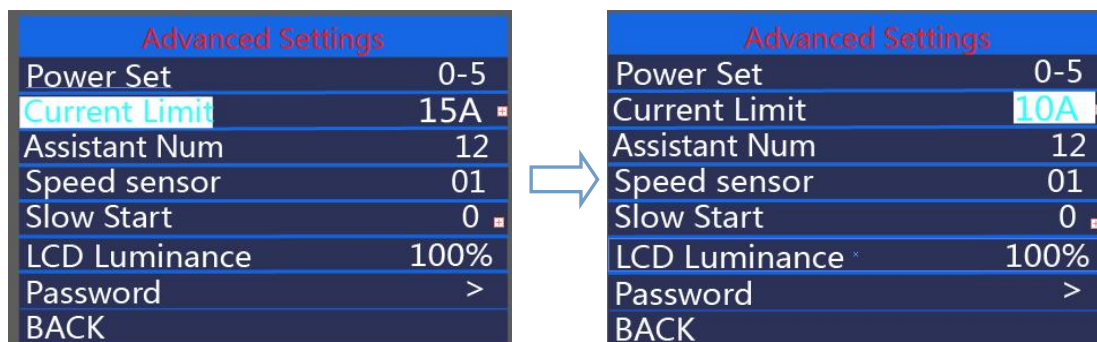

Current limit interface

#### ◆ Assistant Num

**Assistant Num** represents numbers of magnets in the PAS sensor. The settable numbers is 04 to 09, 12, 24, 32. To change the numbers of magnets in the PAS sensor, press the "+" or the "-" button to increase or decrease the values. To confirm and store a changed setting, press **on/off** button.

Hold **on/off** button to return to the home page or press **BACK** to return to home page.

Advanced Settings	
Power Set	0-5
Current Limit	15A
Assistant Num	12
Speed sensor	01
Slow Start	0
LCD Luminance	100%
Password	>
BACK	



Advanced Settings	
Power Set	0-5
Current Limit	15A
Assistant Num	12
Speed sensor	01
Slow Start	0
LCD Luminance	100%
Password	>
BACK	

Assistant Num interface

### ◆Speed Sensor

**Speed Sensor** represents speed sensor settings. The default value is 01. To change speed sensor settings, press the “+” or the “-” button to select the numbers of magnets in the speed sensor (the settable range is 01 to 12). To confirm and store a changed setting, hold the “on/off” button. Or

Hold **on/off** button to return to the home page or press **BACK** to return to home page.

Advanced Settings	
Power Set	0-5
Current Limit	15A
Assistant Num	12
Speed sensor	01
Slow Start	0
LCD Luminance	100%
Password	>
BACK	



Advanced Settings	
Power Set	0-5
Current Limit	15A
Assistant Num	12
Speed sensor	06
Slow Start	0
LCD Luminance	100%
Password	>
BACK	

Speed Sensor interface

### ◆Slow Start

**Slow start** represents slow start up settings. The range is “0-3”, “3” is the slowest. The default is “ 0 ”. To change slow start up settings, press the +/- button to choose the desired value. To confirm and store a changed setting, press the **on/off** button. Or

Hold **on/off** button to return to the home page or press **BACK** to return to home page.

Advanced Settings	
Power Set	0-5
Current Limit	15A
Assistant Num	12
Speed sensor	01
Slow Start	0
LCD Luminance	100%
Password	>
BACK	



Advanced Settings	
Power Set	0-5
Current Limit	15A
Assistant Num	12
Speed sensor	01
Slow Start	2
LCD Luminance	100%
Password	>
BACK	

Slow start interface

◆ **LCD luminance**

**LCD Luminance** represents display backlight brightness. 100% is the highest brightness. 10% is the lowest brightness. 5 settable levels: 100%-75%-50%-30%-10%. The default is 100%. To change the backlight brightness, press the “+” button or the “-” button to choose the desired percentage. To confirm and store a changed setting, press the “ on/off ” button.

Hold **on/off** button to return to the home page or press **BACK** to return to home page.

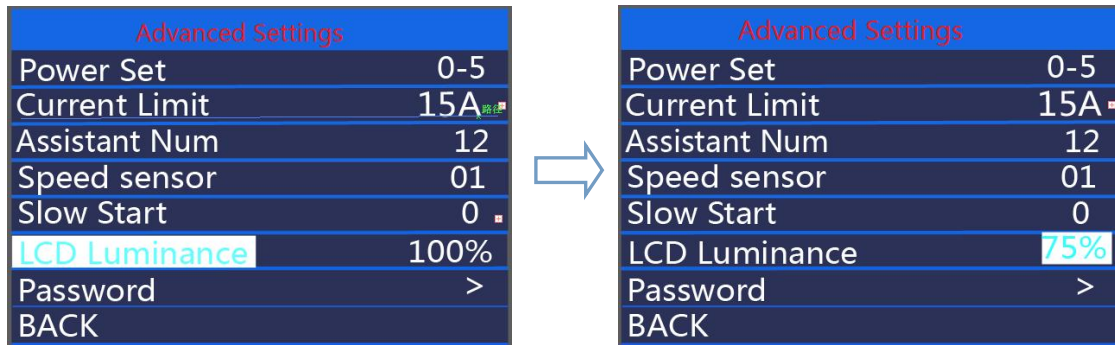

LCD Luminance interface

◆ **Factory settings**

Hold + and on/off button at the same time for 2 seconds to enter the factory settings page. Short press +/- to choose YES or NO. Choose YES and hold on/off button for 2s and the display will be reset to factory settings. When it is done, display returns to home screen. The default value is Restore set: NO

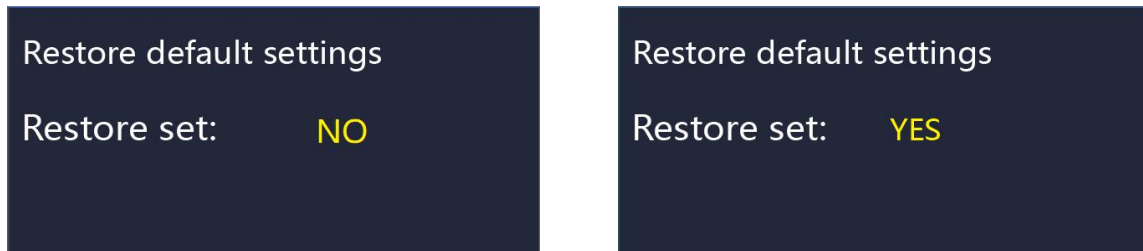

Factory settings

◆ **Password setting**

Short press "+" or "-" to select "Password", short press "ON/OFF" to enter the setting, short press "+" or "-" to select Start PassWord; short press "ON/OFF", Switch "OFF (close)"/"ON (open)" by following below details. The display password is disabled by default





Password input setting interface

◆ **Power-on password enable**

In “**Start PassWord**” interface, choose ‘**ON**’ and press **on/off** to confirm. Meanwhile, display interface asks for a password. Press **+/-** button to increase or decrease numbers and press **on/off** to confirm the first digit and move to the next digit. After 4 digits of a password are input, press **on/off** to confirm and the interface will prompt for re-entering the password. If two inputs are consistent, the system prompts that the password is set successfully. If two inputs are inconsistent, the first input needs to be repeated correctly and confirm the new password again. The interface will be back to original settings page in 2 seconds after the password is set successfully.

Hold **on/off** to return to the home page or by route ‘**BACK**’ → ‘home page’.

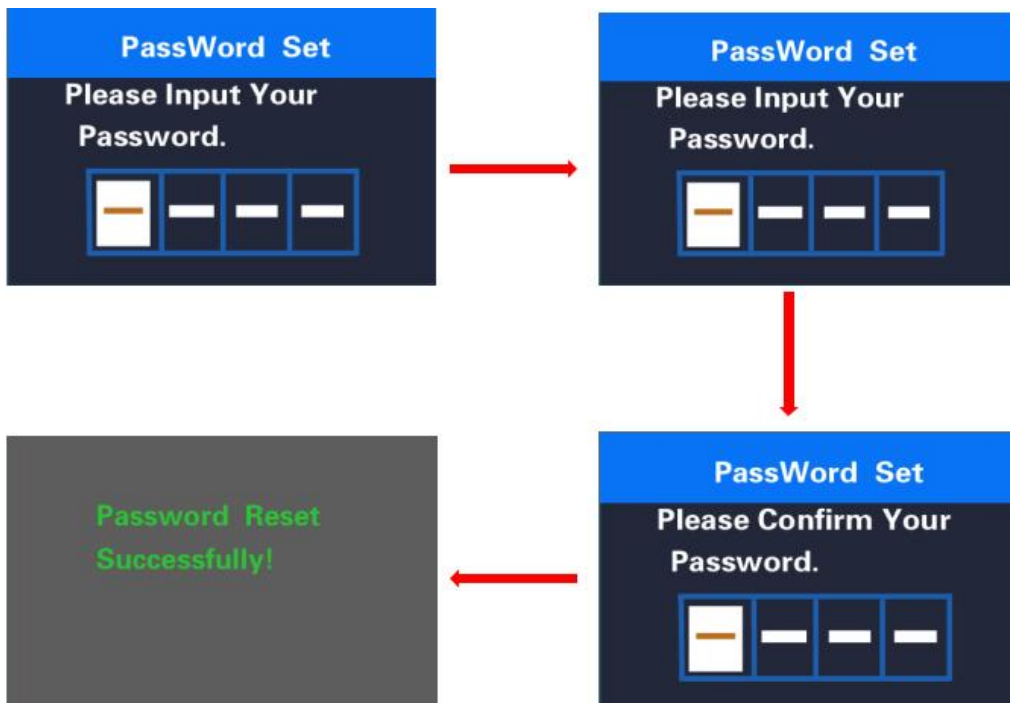

Password enable confirmation interface

◆ **Password Change.**

When password is enabled. '**Reset password**' will add to Password interface. Press +/- button to select '**Reset Password**' and press **on/off** to confirm. Meanwhile, the interface asks for current password. When the correct password is input, the interface prompts to set a new password. Then follow the operations of setting a new password. The interface will be back to original settings page in 2 seconds after the password is reset successfully.

Hold **on/off** to return to the home page or by route '**BACK**' → 'home page'.

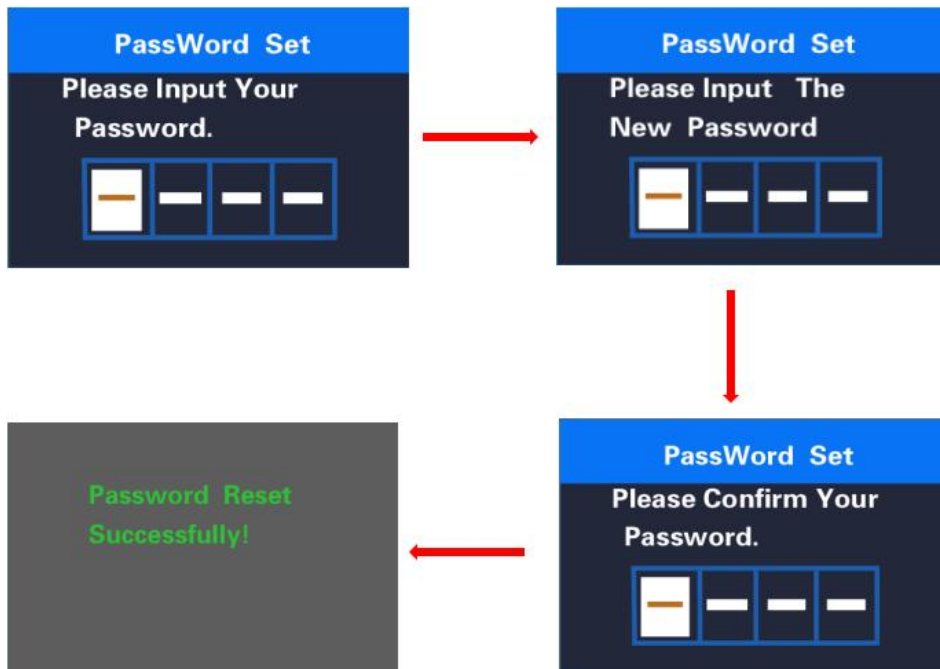

Password change interface

◆ **Password Disable**

In "**Start PassWord**" interface, choose **OFF** and short press **on/off** to confirm. Meanwhile, display interface asks for a password. When the correct password is input, the display prompts 'password function disabled'. After 2 seconds, the interface will be back to original settings page.

Hold **on/off** to return to home page or by route '**BACK**' → 'home page'.

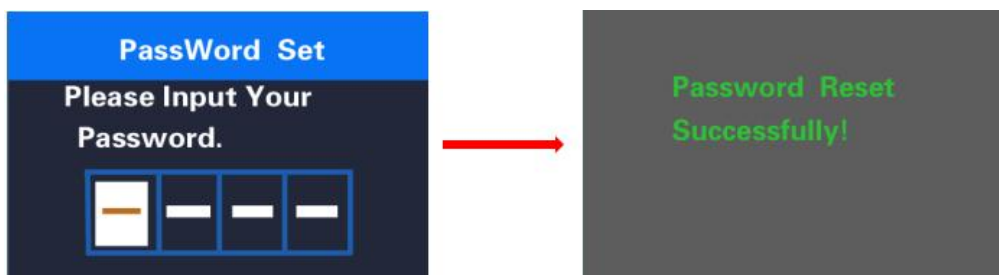

Password disable interface

■If there is no operations in one minute, the display will exit the settings state.

◆Display connection layout:

Julet 5 pins male connector. Type: JL-F39-Z508JG



**Display male connector wiring**

Wire no.	Code	function
1	VCC	Display power supply
2	KP	Controller power control wire
3	GND	Display GND
4	RX/CAN H	Display - RXD
5	TX/CAN L	Display- TXD

**Attached list 1: error code definition**

Error code	Definition
21	Current fault
22	Throttle fault
23	Motor phase absence
24	Motor hall signal fault
25	Brake fault

30	Communication fault
31 (New EN standard)	Display MOSFET short circuited
32 (New EN standard)	<b>on/off</b> button is stuck.
33 (New EN standard)	- button is stuck
34 (New EN standard)	Over voltage

**Attached list 2: PAS ratio default value table**

<b>level</b> PAS level options	1	2	3	4	5	6	7	8	9
0-3/1-3	50%	74%	92%	—	—	—	—	—	—
0-5/ 1-5	50%	61%	73%	85%	96%	—	—	—	—
0-7/ 1-7	40%	50%	60%	70%	80%	90%	96%	—	—
0-9/ 1-9	25%	34%	43%	52%	61%	70%	79%	88%	96%

## Quality Assurance and Warranty Scope

### Warranty

- (1) The warranty will be valid only for products used in normal usage conditions.
- (2) The warranty is valid for 24 months after the shipment or delivery to customers

II The following cases do not belong to our warranty scope.

1. The display is demolished.
2. The damage of the display is caused by wrong installation or operation.
3. Shell of the display is broken when the display is out of the factory.
4. Wire of the display is broken.
5. The fault or damage of the display is caused by the force majeure (e.g., fire, earthquake, etc.).
6. Beyond Warranty period.

### Warnings:

- ◆ Use the display with caution. Don't attempt to release or link the connector when battery is on power.
- ◆ Try to avoid hitting the display.
- ◆ Don't modify system parameters to avoid parameter disorder.
- ◆ Make the display repaired when error code appears.

**Special note:** this KD686 manual is a general-purpose version, and the parameter values are for reference only.

# Maintenance

## Regular maintenance:

- maintain all components of the electric bicycle clean
- use only the recommended and tested cleaning materials
- regularly lubricate the chain with suitable oils
- in winter, clean the electric bicycle after each ride and pay increased attention to removing salt from battery contacts and other connectors
- while handling the electric bicycle, make sure the cables of the electric system are not damaged. Damaged cables pose a risk of electric shock
- regularly check all connections for correct tightening and brakes for correct function. Check also individual parts of the electric bicycle for damage. For example: cracks on the frame, fork, handlebars, stem, damage to cables, damage to battery pack, etc.

## Battery transport:

Battery transport is subject to the requirements of regulations on dangerous goods. Private users may transport undamaged batteries on roads without having to conform to other conditions.

In case of transport by commercial users or by third parties it is necessary to comply with special packaging and marking requirements (e.g. ADR regulations)

Batteries should only be sent if the battery pack is undamaged. Plug loose contacts and pack the battery to prevent its movement in the packaging. Notify the forwarding service that the transport concerns dangerous goods.

## Battery storage:

Store the battery in a dry and well-ventilated place, out of reach of direct sunlight and other heat sources. In case of cold storage it is necessary to let the battery warm up to normal room temperature (20°C) before putting into operation.

Never leave the battery fully discharged. It could result in its permanent damage. For long-term storage keep the battery fully charged. However, do not store it while permanently connected to the charger or installed in the electric bicycle.

Li-Ion batteries are fully recyclable. After expiry of the battery life you can return it at any collection point or your dealer.

If you use an e-bike in hard conditions (long-term use of the maximum assistance), for longer ride at higher temperatures (30 ° C or above), in direct sunlight or when the battery is partially discharged and a combination of these situations is it possible that bike will automatically switch off. This is a fuse protecting the control unit against burning. We recommend stop the ride and let the bike (control unit) cool down little bit. This is not a defect.

# Possible problems and their solutions

In case of system failure perform its diagnostics or contact your dealer.

## **The control LCD display is not on:**

- always make sure the battery is charged
- check whether the battery is inserted correctly, whether the battery switch is on
- check the connections of the control unit and the display

## **The motor does not start when the walk assistance button is pressed**

- check the connection of the motor cable (at the motor and the control unit)
- check the connections of the control unit and the display

## **The motor does not start when rotating the pedal cranks (pedalling)**

- check the connection of the pedalling sensor to the control unit
- check the distance between the pedalling sensor and the magnet disk (max. 4 mm)
- check whether the disk is firmly attached to the central axle and does not spin freely
- in case of use of compact-type pedalling sensor

# Warning

When there is a problem with the electric bicycle, it can show error messages. LCD display will show the icon and an error code will be displayed on the speed display. Error codes are marked from 01 E~FF E; see their meaning in the table below.

Error code	Description	Solution
6	Low battery voltage	Check battery voltage
7	High voltage protection	Check battery voltage
8	Hall probe error	Check motor
9	Three-phase supply error	Check motor
11	Overheating controller sensor	Check controller
12	Overvoltage controller sensor	Check controller
13	Overheated battery	Chcek battery
21	Speed sensor error	Check the position of the sensor
22	BMS communication error	Change battery
30	Communication error	Check connectors

# Electric set warranty

## **Complaint procedure:**

Submit any complaints concerning the electric set or the battery to your dealer.

When filing a complaint, submit a proof of purchase and a warranty certificate with the registered serial number of the battery and indicate the reason for the complaint and a description of the defect.

## **Warranty conditions:**

24 months for electric bicycle components – applies to manufacturing and material defects beyond normal wear and tear caused by use.

12 months for battery life – the nominal battery capacity does not drop below 70% of the total capacity over 12 months from the sale of the electric bicycle.

## **Warranty conditions:**

The electric set must be used exclusively for the purposes it is intended for.

The electric set must be used, stored and maintained in accordance with these Operating Instructions.

## **A warranty claim shall expire:**

If it is found out that the damage to the product is due to the user's fault (accident, inexpert handling beyond the framework of these Operating Instructions, tampering with the structure of the electric bicycle or connection of the electric system, improper storage, etc.).

Expiry of the warranty period.

**The warranty only applies to the first owner**



## Warning

If you do not understand any of the points in these Operating Instructions, please contact the dealer for explanation. Please read the whole manual!

Do not lend the e-bike to persons not briefed in its use and operation. Complaints resulting from improper handling will not be accepted.

The LF Energy electric bicycle is not intended for use by children under 15 years of age. Likewise, the electric bicycle cannot be used by persons unable to pedal or handle it independently. The manufacturer is not to be held responsible for any potential injuries or damage to the bicycle!

Ideal weather conditions for using an electric bicycle are dry days, when the outdoor temperature is above 10°C. When used at lower temperatures, the battery discharges faster due to physical phenomena. Using the electric bicycle at temperatures below 0°C is not recommended.

Do not expose the bicycle to direct sunlight as it is fitted with a protective temperature sensor for the electric motor.

Never submerge the battery, the charger and other electric components in water or another liquid.

Never wash the electric bicycle in a pressure washer (WAP) and always remove the battery before washing

It is forbidden to tamper with the connections of the electric motor, the control unit and the battery. Violating this section may result in the warranty not being acknowledged or in irreversible damage to the electric bicycle.

DO NOT USE chargers and components other than the ones included with the electric bicycle.

We cannot be held responsible for damage caused by use of other non-approved goods

# **LEADER FOX**



Enjoy many pleasant and safe kilometres on your new electric bicycle.

## **Your Leader Fox Team**



**Czech brand of electric bicycles.  
BOHEMIA BIKE**

**Address**

Pujmanové 1753/10 a  
140 00 Praha 4 - Nusle

**Development, design and manufacturing**

Okružní 697  
České Budějovice 37001

Phone: 388 314 885

Email: [info@leaderfox.cz](mailto:info@leaderfox.cz)

