

LEADER FOX



Electric Bicycle Operating Instructions

Under the law, the dealer is obliged to attach the LEADER FOX Electric Bicycle Operating Instructions to every product



E – BIKE POWER RIDE

Argus



Introduction



Dear users,

Please read carefully all the information regarding your E-LF product to ensure optimal functioning of your e-bike. The following text containing a comprehensive description will provide you with information on all aspects and details (including installation, setting up and general use of the display) regarding the use of our display. This instruction document will also help you solve potential problems and failures.

What is an electric bicycle?



Electric bicycle is a conventional bicycle with an electric drive added to assist the rider. The motor function is actuated by pedalling, which is scanned by a special sensor installed in the pedal hub. Therefore, you have to keep pedalling on an e-bike, the motor is there only to help you. You can set an electric bicycle in motion also using a control button or an accelerator but only up to the maximum permitted speed of 6 KMPH (e.g. for walk assistance). The maximum speed of an e-bike with motor assistance is 25 KMPH, with a 10% tolerance (when this speed limit is reached, the motor switches off and you need to pedal just like with a regular bicycle). When your battery runs out of power or your motor is off, you can ride your electric bicycle as a conventional bike, without any resistance at all.

From the point of view of the Road Traffic Act, an electric bicycle whose features conform to European standard EN 15194-1 is regarded as a regular bicycle, i.e. you can ride on bike trails, do not need a driver's license and a helmet is mandatory only up to 18 years of age.

Description



Factors influencing the electric bicycle range

1. Rolling resistance of the tyres. Leader Fox e-bikes are fitted with tyres with low rolling resistance and increased resistance to puncture. It is also important that the tyres are inflated properly. Therefore, if the tyres of your electric bicycle are underinflated, the range will decrease.

2. Weight of the electric bicycle. The lower weight of the electric bicycle, the greater the range.

3. Battery status. It depends on whether the battery was fully charged before your trip. It is also to be expected that the higher the number of discharge cycles the battery has undergone, the smaller capacity it has.

4. Profile and surface of the track. The higher the elevation difference and the steeper hills you negotiate and the worse surface, the shorter the range.

5. Riding mode. It depends on which of the three riding modes you have set.

6. Continuity of riding. The more braking and acceleration, the shorter the range.

7. Air resistance. For example, it depends on whether we ride a bicycle with low frame and sitting upright or whether we ride sporty bicycle with seat set to the same height as the handlebars.

8. Wind strength. The stronger the wind we have back, the longer the range and vice versa.

9. Weight of the rider and load. The greater the weight, the shorter the range.

10. External temperature. The lower the temperature, the less battery capacity can be used while riding.

Electric set

GX Ultimate

The system uses monitoring of torque, monitoring of speed of the pedal assist system and monitoring of real speed of wheels.

The system uses a dual protection feedback for measuring the speed signal to ensure safety and reliability of the system.

It has high starting torque, maximum torque of over 95 Nm, suitable especially for riding uphill.

It is highly efficient with low power consumption, long range, low noise levels, and smooth operation.

Description and scope of operation:

The motor unit works properly under the following operating conditions:

Temperature range - 20 to + 40 °C

Maximum torque 95 Nm

Weight – 2.9 Kg

Dustproof/ waterproof-IP65

Certified-CE ROHS/ EN15194:2017

Description of the power unit is placed on the cover and shows the following information:

NUA213F – Engine model

E – assist for full suspension bikes

F – assist for hardtail bikes

29X18 – Date of manufacture, indicating it is manufactured on October 29, 2018

0001 – Production serial number

DC36V – Rated Voltage

250 W – Rated engine power

120rpm – Rated engine rotation speed

25 km/h – Max speed

Dimensions of the power unit:

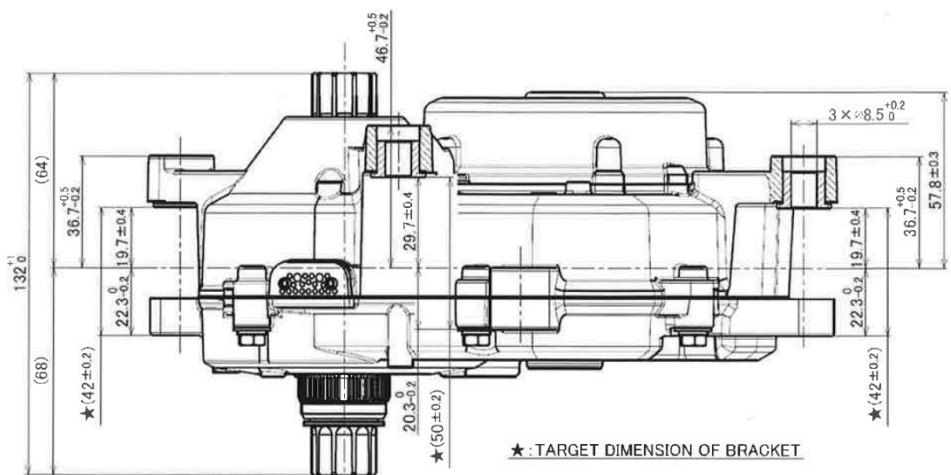
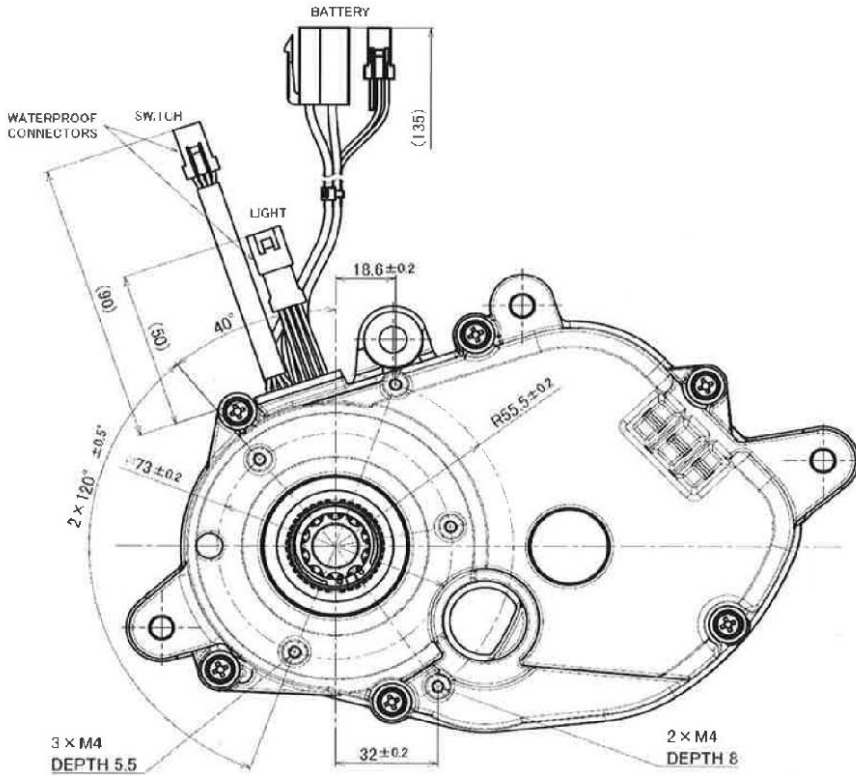

Safety instruction

Motor:

Waterproof IPX5, do not expose to high-pressure, heavy sprays of water.

Do not submerge the motor in water.

In the case of motor submersion in water, switch the unit off and stop using it.

Do not put the motor near magnetic field, it can tamper with sensors setting.

Battery:

Waterproof IPX5, do not expose to high-pressure, heavy sprays of water.

Do not submerge the battery into water.

Do not expose the battery to fire.

Do not use the battery for other appliances. It has been made specifically for this model.

Do not dismantle or modify the battery.

Do not connect the positive and negative poles of the battery.

Charger:

Do not dismantle or modify the charger.

Do not use the charger for other appliances. It has been made specifically for this model.

Do not throw the charger into fire or water.

Do not touch the charger with wet hands.

Keep the charger from animals or children.

Do not cover the charger.

Do not use the charger if it is broken

Charging set



Battery

Battery charging and maintenance:

Charge the battery in a dry environment to avoid short-circuit damage.

Charge the battery to at least 60% of the capacity once every 3 months even when the bicycle is not used.

Do not cover the battery or the charger.

Do not leave the battery constantly connected to the power source.

Do not use the battery for other appliances. It has been made specifically for this model.

Do not disassemble or modify the battery pack.

Do not throw the battery into fire or expose it to extreme temperatures.

Recharging time from zero to 100% is 1-7 hours.

Drive warranty:

The warranty applies to those drive parts that are not sensitive to improper handling (pack, electronics, charger, etc.); such parts are covered by a 24-month warranty.

The warranty does not apply to chemical parts of the battery and to capacity reduction due to normal use (39% after the expiry of two years); those parts are covered by a 12-month warranty.

Charging:

The battery is the most expensive part of an electric bicycle; therefore, pay increased attention during handling, charging and storage. The battery is sensitive to precise charging. Therefore, it is necessary to charge Li-Ion rechargeable batteries using only a charger supplied by us. Connect the charger to 220-240 V power outlet. 5A protected circuit is sufficient. The charger will automatically suspend charging when full capacity of all cells is reached.

We recommend discharging the battery in full after each ride to ensure that your battery will be up to its full capacity for your next ride. Charging the battery may last 1 to 5 hours depending on the condition of the battery cells. Charge it exclusively in covered dry areas (moisture and dripping water can damage the charger) at a temperature of 5 to 40°C.

The charging process is indicated by a red glowing LED. It will turn green when the battery is charged and the charging process is complete. The battery contains a charge-monitoring indicator (when the charge indicator button is pressed, the light indicator will come on).

Normal battery behaviour:

If the motor stops running smoothly and switches to intermittent operation, it could be a sign of low battery capacity. In that case switch off the electric drive system and continue without motor assistance, as if riding a conventional bicycle.

Battery warming is normal and does not indicate any defect. The battery is protected by a temperature sensor and switches off automatically in case of excessive overheating. Wait until the battery cools down to its normal operating temperature and then ride on.

If you feel your total battery capacity has dropped, it could be caused by charging or operation in suboptimal climatic conditions. Carry out 3 full charging cycles. Fully discharge the battery while riding and then charge to its full capacity at room temperature.

If the charge indicator shows that the battery is discharged, there is still a minimum voltage level in it which protects it against damage but is not enough to power the electric bicycle. Recharge the battery as soon as possible. Never leave the battery fully discharged, it could result in its damage.

In the case, that the battery will be turned on more than 30 min and bike will not be used, the battery will be automatically switched off.

Battery is fully shutdown after 48h. After that time period you have to first activate the battery by switch button or connect battery with charger.

Proper care of the battery prolongs its life.

LCD display

Product:

Side display Panasonic

Supplier:

Panasonic

Parameters:

Color display

Protocol UART

USB port 5V DC, max. 1 A

Operating temperature – 10 ~ 40 °C

Storage temperature – 20 ~ 50 °C

CE / IP65 water and dust proof / ROHS.

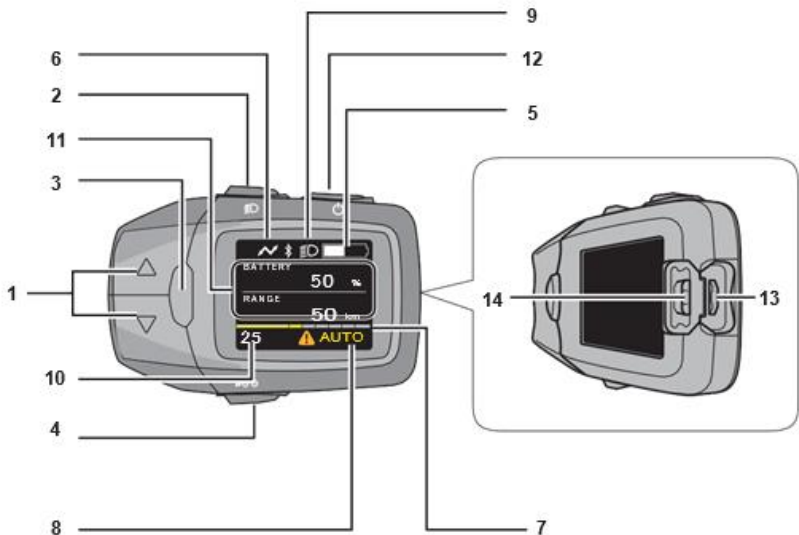

1 Assist mode select buttons

Selects the assist mode from [HIGH], [STANDARD], [ECO],[NO ASSIST] and [AUTO].

* If [AUTO] mode is not installed, [AUTO] is not indicated on the display unit.

2 Night mode button

* Lights the backlight of the display unit.

When power is supplied to the head light or tail lamp from the battery on the electric bicycle, the head lamp or tail lamp lights. It depends on local regulation.

3 [information] button

Switches display items such as distance travelled.

4 Bicycle mark button (Walk assistance)

Drive can be assisted up to 6 km/h when pushing the electric bicycle with a heavy load on it.

5 Battery level display

Displays the battery remaining capacity.

6 USB connection mark

Displayed when an external device (e.g. mobile phone) is connected to the display unit for charging.

7 Assist power indicator

Displays in the form of a graph how much the rider is being assisted. The larger the number on the graph, the more the rider is being assisted.

8 Text indication

Displays the current assist mode, etc.

9 Night mode indicator

Lights when the night mode button is pressed.

10 Speed indication

Displays the current travel speed.

11 Value indication

Displays distance travelled, total distance travelled, maximum speed, etc.

12 Power button

Turns on and off the electric bicycle system.

13 Micro USB port

Used to charge an external device (e.g. mobile phone).

14 Rubber cap

Protects the Micro USB port.

Assembly instructions

Insert the side display on the band mounted on the handlebar of the electric bicycle.

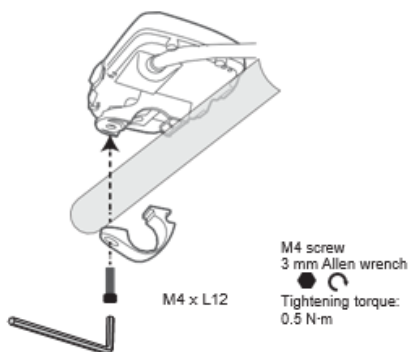

Methods of Use

To enable the assist function or display the various indications, press the power button on the console to turn on the electric bicycle system.

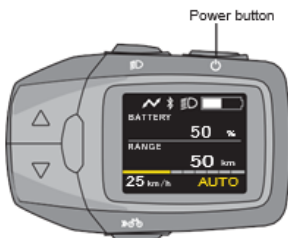

Turning on the electric bicycle system

Press the power button on the side display.

- The system starts with "OFF", unless the bicycle maker prepared it to an assist function. To change the assist mode, refer to page 7.

Attention

- Before pressing the power button, do not place your feet on the pedals of the electric bicycle. Otherwise, this will result in a torque sensor error or weak assist force.
Press the power button again without placing your feet on the pedals.
- While pressing the power button, do not press any other buttons, otherwise an error may be displayed.
In this case press the power button again without your feet on the pedals.
- Do not turn on/off the power button during riding. If the assist function is not required, press the assist mode select buttons (▲ ▼) to select [OFF].

Note

- The assist function of the electric bicycle will not work in the following cases:
 - When you stop pedalling
 - When a speed of 25 km/h is reached (The assist function starts to work by starting pedalling again at 25 km/h or less.)
 - When there is no remaining battery power

Turning off the electric bicycle system

Press the power button on the console when the electric bicycle system is turned on.

Note

- Even if the power button is not pressed to turn off the electric bicycle system, the power automatically turns off to save energy if the electric bicycle is not used for about ten minutes (for example, when the electric bicycle is parked).





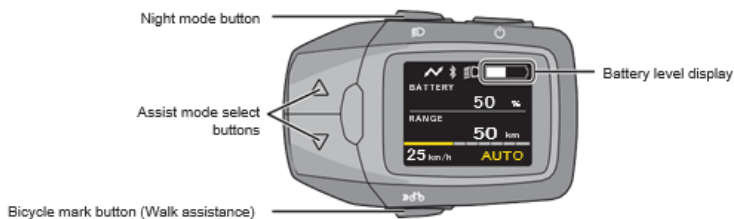











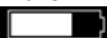

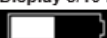

Control

Use the buttons on the Side display to change the assist mode. This is shown as well as the remaining capacity of the bicycle battery in the side display.

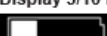
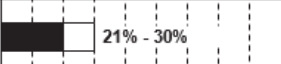
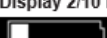
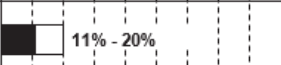

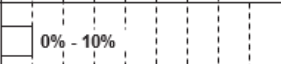
Battery level display

The battery charge status indicates the remaining capacity of the battery in the electric bicycle. The charged state of the battery on the electric bicycle can also be checked by the battery LED.

Side Display LCD screen display	Battery level (%)				Guide
	20	40	60	80	
Display full 					<p>Ride assistance available</p> <p>When you turn the side display on after charging it, the battery level display will decrease in increments of 1/10. The percentage display for battery level will decrease in increments of 1%.</p>
Display 9/10 full 					
Display 8/10 full 					
Display 7/10 full 					
Display 6/10 full 					
Display 5/10 full 					
Display 4/10 full 					
Display 3/10 full 					
Display 2/10 full 					
Display 1/10 full and red 					
Display empty with diagonal line 					
OFF: Assistance stopped 					

Assist mode select buttons

The five assist modes can be selected by pressing the assist mode select buttons.

		Assist Mode
 <p>Assist mode select buttons</p>	[HIGH]	<p>... *¹⁾On flat and uphill roads, a powerful assist force is provided for a comfortable ride on slopes and carrying heavy loads.</p> <p>① ↓ ↑ ②</p>
	[AUTO]	<p>... *¹⁾Depending on road conditions, the assist force automatically changes from low to powerful.</p> <p>① ↓ ↑ ②</p>
	[STD]	<p>... *¹⁾On flat and uphill roads, a mid assist force is provided.</p> <p>① ↓ ↑ ②</p>
	[ECO]	<p>... *¹⁾On flat and uphill roads, a low assist force is provided allowing for a longer distance traveled by a single charge.</p> <p>① ↓ ↑ ②</p>
	[OFF]	<p>... *¹⁾No assist force.</p>

¹⁾ The assist force may change depending on weather conditions, road conditions, bicycle conditions, or riding styles.

• Change in assist force

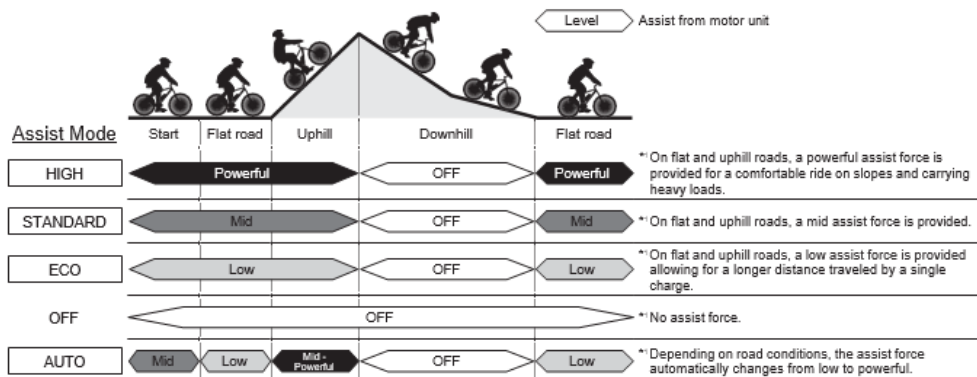

Press the assist mode select buttons (▲ / ▼) until the desired assist mode is displayed.

- Side display on the console: The assist mode selected in the assist mode display is displayed.

Display menu, parameters setting:

Bicycle mark button (Walk assistance)

This is the push-assistance function that assists you by providing drive up to 6 km/h, for example, when you are carrying a heavy load.

Hold down the bicycle mark button (Walk assistance).

- When you release your finger from the bicycle mark button (Walk assistance), or the electric bicycle exceeds a speed of 6 km/h, the function will not be activated.

Note

- When the pedals hit the curb or other objects and the push-assist function stops, hold down the bicycle mark button (Walk assistance) again.

Indication of speed, distance

The current speed is displayed at Speed indication at all times. (Fig. 3)

For the distance display and battery level, items and numerical values are displayed at Text indication and Value indication, respectively. (Fig. 3)

Items can be switched.

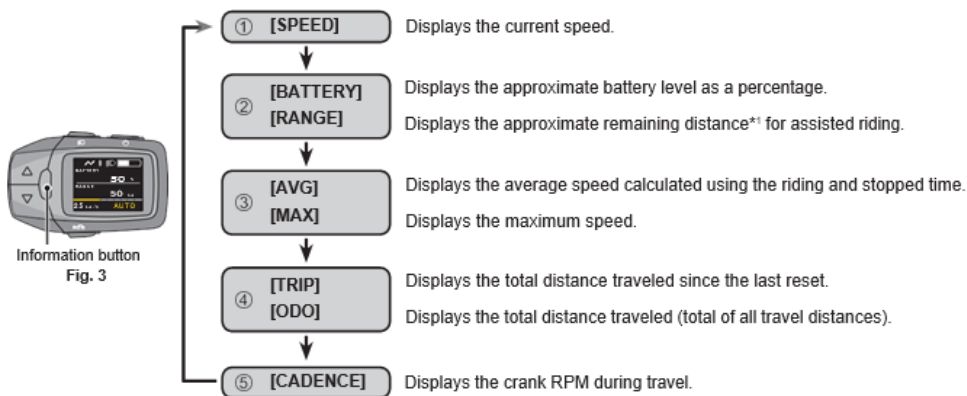

*1 This is a rough value because the remaining battery capacity is calculated using the amount consumed.

Press the information button on the side display. (Fig. 3)

- Each press of the button switches the item.

■ If you want to simultaneously reset distance traveled (TRIP), average speed (AVG), and maximum speed (MAX)

- ① Use the information button to display [TRIP], [AVG] or [MAX].
- ② Hold the information button down until the display shows 0.
- It is not possible to reset values individually.

Basic settings

Basic settings such as the language displayed on the side display, adjustment of backlight brightness and time can be changed. Access the basic setting menu, and change the settings as desired. In the basic setting menu, the following items can be switched and set.

Setting		Description
[DISPLAY]	[BRIGHTNESS]	The brightness of the backlight of the side display can be adjusted in 10 stages. The brightness can be set separately for when the night mode indicator is turned on and when it is turned off. *When light settings are disabled, the night mode indicator does not light up but the backlight switches.
	[LANGUAGE]	The language displayed on the side display can be switched. The language can be selected from the following ten languages: English, German, Dutch, French, Italian, Spanish, Danish, Slovak, Polish, Czech
[BIKE]	[UNIT]	The display unit for speed and distance can be toggled between kilometers and miles.
	[WHEEL]	The tire circumference matched to the electric bicycle currently in use can be set.
	[ODO]	The display of the total distance traveled can be changed.
[Bluetooth]	[CPP]	Uses the Cycle Power Profile to connect to the corresponding smartphone app.
	[NAVIGATION]	Hides and displays the navigation screen (komoot).
	[komoot]	Connects to komoot (smartphone app).
[CERTIFICATION]		Displays Technical Standards Conformity information.
[FACTORY RESET]		Resets the Side Display to factory settings.

Changing the settings and display

■ Operation method for the settings menu

- ① With the Side Display turned ON, press both the ▼ button and [information] button for more than 3 seconds.

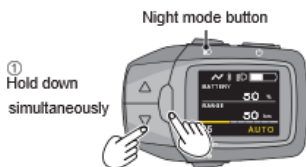

- ② Use the assist mode select buttons (▼ ▲) to select the desired menu, and then press the [information] button.
- The system then enters the setting mode for the selected menu.

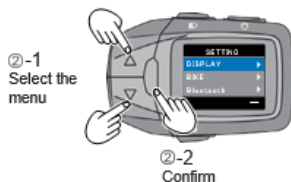

- ③ Use the assist mode select buttons (▼ ▲) to change the settings, and confirm by pressing the [information] button.
- If you wish to continue configuring the settings, repeat steps ② and ③.

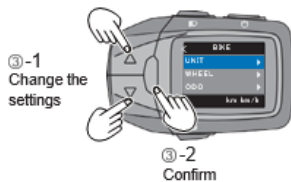

- ④ Press the night mode button
- The system returns to normal mode.

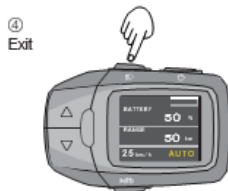

■ Configuring [DISPLAY] settings

Select [DISPLAY] from the settings menu, and then press the [information] button.



1) Setting [BRIGHTNESS]

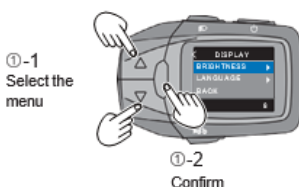

① Use the assist mode select buttons (▼ ▲) to select [BRIGHTNESS], and then press the [information] button.

- The current setting is displayed.



② Use the assist mode select buttons (▼ ▲) to adjust the brightness, and then press the [information] button.

- Settings are changed.

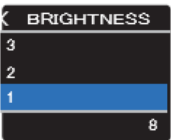
Backlight brightness value options	Max: 10	Min: 1
		

You can adjust the brightness of the backlight for when lights are off and when lights are on.

Use the night mode button to select the state of the lights for which you want to configure the settings (i.e. when lights are on or off), and then use the settings menu.

Language settings

2) Setting [LANGUAGE]

- ① Use the assist mode select buttons (▼/▲) to select [LANGUAGE], and then press the [information] button.

- The current setting is displayed.

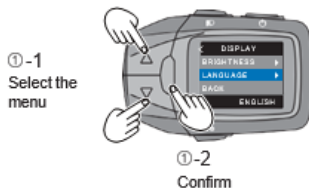

- ② Use the assist mode select buttons (▼/▲) to select the language, and then press the [information] button.

- Settings are changed.

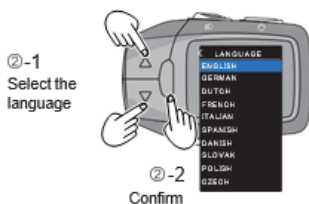

No.	Language
1	ENGLISH
2	GERMAN
3	DUTCH
4	FRENCH
5	ITALIAN
6	SPANISH
7	DANISH
8	SLOVAK
9	POLISH
10	CZECH

Console

■ Configuring [BIKE] settings

Select [BIKE] from the settings menu, and then press the [information] button.

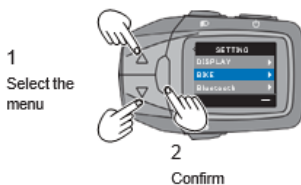

1) Setting [UNIT]

Perform this procedure to switch the units for speed and distance.

① Use the assist mode select buttons (▼/▲) to select [UNIT], and then press the [information] button.

- The current setting is displayed.

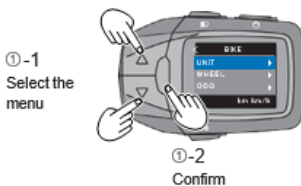

② Use the assist mode select buttons (▼/▲) to select the units, and then press the [information] button.

- Settings are changed.

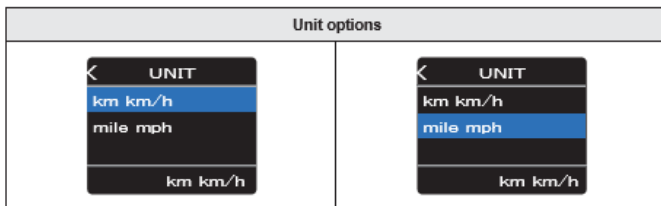

2) Setting [WHEEL]

Perform this procedure to set the tire circumference to match the tires on the bicycle.

① Use the assist mode select buttons (▼/▲) to select [WHEEL], and then press the [information] button.

- The current setting is displayed.





② Use the assist mode select buttons (▼/▲) to set the thousands place of the number for the circumference of the tires, and then press the [information] button.

- The settings changes, and the underbar moves to the hundreds place of the number. Repeat this process until you reach the ones place.

*Tire circumference is only saved if you set all places of the number.

*It is not possible to move the underbar back to a previous place.

Tire circumference value input	Max: 2499	Min: 1000
		

Notifications

- The factory setting for tire circumference is 2200 mm. This must be changed if you change the tires on your bicycle.
 - If you do not change this setting, speed and distance will not be accurately displayed.

3) Setting [ODO]

Perform this procedure to modify the total distance that is automatically displayed.

① Select [ODO] from the settings menu, and then press the [information] button.

- The current setting is displayed along with an an underbar under the tens of thousands place of the new number.

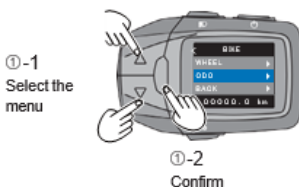



② Use the assist mode select buttons (▼/▲) to set the tens of thousands place of the total distance, and then press the [information] button.

- The settings changes, and the underbar moves to the thousands place of the number. Repeat this process to set the total distance to the first decimal place.

*The total distance is only saved if you set all places of the number.

*It is not possible to move the underbar back to a previous place.

Total distance value entry	Max: 99999.9	Min: 00000.0
		

■ Performing a factory reset

- ① Select [FACTORY RESET] from the settings menu and press the [information] button.
 - It is not possible to reset values individually.

■ Pairing with and connecting to a Bluetooth device

Preparations

- Ensure that the Bluetooth device is within 1 m of the Side Display.
- If necessary, check the operation method and other information in the user manual for the Bluetooth device.
- Turn the Bluetooth device on, and enable the Bluetooth function

- ① Select [Bluetooth] from the settings menu, and then press the [information] button.



1) Setting [CPP]

Perform this procedure to pair with a device that supports CPP.

- ① Use the assist mode select buttons (▼ ▲) to select [CPP], and then press the [information] button.
- ② Select [CONNECT] to start pairing with the Side Display.
 - While not connected: [CONNECT] and [BACK] are displayed.
 - While connected: [DISCONNECT] and [BACK] are displayed. Select [DISCONNECT] to cancel the pairing with the device that is currently connected.

*The device name for this device when paired is [Panasonic + 6 alphanumeric characters] as shown at the bottom of the CPP screen.



While not connected	While connected
<p>Device name</p>	

- ③ Start pairing on the Bluetooth device. On the Bluetooth device, select the device name [Panasonic + 6 alphanumeric characters].
- ④ Check that the Side Display and Bluetooth device are connected.

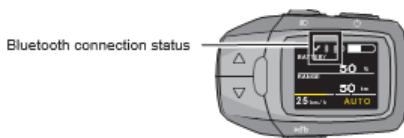

When using Bluetooth devices...

■ Specified frequency band

The 2.4 GHz frequency band used by this product is also used by industrial, scientific, and medical equipment such as microwave ovens, as well as premises radio stations (license required) used for identification of moving objects in factory production lines and in other such places, specified low-power radio stations (no license required), and amateur radio stations (license required).

- ① Before using this device, check that there are no premises radio stations used for identification of moving objects, specified low-power radio stations, or amateur radio stations nearby.
- ② If this device causes interference with premises radio stations used for identification of moving objects, you should immediately change the place you use it in or halt the use of radio waves.

■ Device certification

This device has received a Technical Standards Conformity Certification based on the Radio Act, so it does not require a radio station license. However, the following acts are punishable by law if performed on this device.

- Disassembly/modification

■ Usage limitations

- This device is not guaranteed to be able to communicate wirelessly with every Bluetooth® device.
- Any Bluetooth® device with which wireless communication is to be performed must be certified as compliant with the standards set by Bluetooth SIG, Inc. However, it may not be possible to connect to a device even if it is certified as being compliant with these standards due to its usage and settings, and no guarantees are made regarding the operating method, display, or operation.
- This device supports security functions that conform to Bluetooth® standards, but security may not be sufficient depending on the usage environment and details of the settings. Please be aware of this when using wireless communication.
- Please understand that Panasonic shall accept no responsibility for any data or information leaks that occur during wireless communication.

■ Usable range

Use a Bluetooth® device within 1 m of this device. The usable range may be shorter depending on whether the surrounding environment has any obstacles or any other devices that may cause interference. Please note that the usable range above is not guaranteed.

■ Impact from other devices

- Do not use the device in places where magnetic fields, static electricity, or radio wave interference occur. If used in the vicinity of the following, communication may be lost or experience delays.
 - Microwave ovens
 - Digital cordless telephones
 - Other devices that use radio waves in the 2.4GHz band (wireless audio devices, game consoles, etc.)
 - Metal objects and other such objects that are prone to reflecting radio waves
- In the vicinity of broadcasting stations and other such things where the radio waves in the periphery are very strong, the device may not work correctly.

■ Restrictions on purpose of use

This device assumes general usage, and it is not designed or manufactured for high-safety usage*. Do not use for any purpose that requires high safety.

* High-safety purposes refer to uses that require an extremely high level of safety in controls that involve a major direct risk to life or risk of injury.

Examples: Control of nuclear reactions in nuclear power facilities / automatic flight control in aircraft / air traffic control / transport control in high-volume shipment systems / medical devices for life support / missile launch control in weapons systems, etc.

2) Setting [NAVIGATION]

① Use the assist mode select buttons ( ) to select [NAVIGATION], and then press the [information] button.

- When hidden: [ON] and [BACK] are displayed. When [ON] is selected, navigation information is displayed on the normal mode screen.

*Navigation is automatically set to ON when pairing with komoot is started.

- When shown: [OFF] and [BACK] are displayed. When [OFF] is selected, navigation information displayed on the normal mode screen is hidden.

*Navigation is not automatically switched OFF when pairing with komoot is cancelled.

①-1
Select the
menu

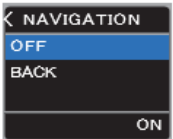

①-2
Confirm

When hidden	When shown
 <p>Current status</p>	

3) Configuring the [komoot] connection

Perform this pairing procedure to display the navigation information specified using the Side Display komoot app.

Smartphone

① Bluetooth Connect settings in smartphone komoot app

- From the device types, select [Panasonic Device].

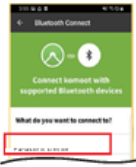

The screenshot shows the 'Bluetooth Connect' screen with a green header. Below the header is a 'Connect handset with supported Bluetooth devices' section. A red box highlights the 'Panasonic Device' option under the heading 'What do you want to connect to?'. A vertical dotted line with a downward arrow indicates the flow to the next step.

② When the device is correctly recognized by your smartphone and the connected device appears on the app screen, pairing is complete.

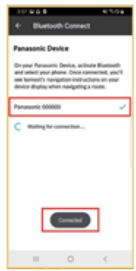

The screenshot shows the same 'Bluetooth Connect' screen. Under the heading 'Panasonic Device', there is a list of devices with 'Panasonic 000000' selected and checked. Below the list is a 'Waiting for connection...' status and a red box highlights the 'Connect' button.

Side Display

① Select [komoot] from the settings menu, and then press the [information] button.



The screenshot shows a side display device with a Bluetooth settings menu. Two hand icons indicate pressing the 'komoot' option (labeled ①-1) and the information button (labeled ①-2). The menu options are 'Bluetooth', 'LOCATION', 'LowBat', and 'BACK'. Below the screenshot, it says 'Confirm'.

② Select [CONNECT] from the komoot menu, and then press the [information] button.

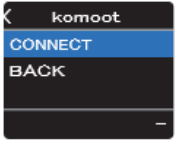

The screenshot shows the 'komoot' menu with the 'CONNECT' option highlighted in blue. The other options are 'BACK' and a minus sign.

③ When your smartphone's name is recognized, select it and press the [information] button.



The screenshot shows the 'komoot' menu with 'My Smartphone' highlighted in blue. The other options are 'AAAAA', 'BBBBBBB', and 'BACK'.

④ When pairing with your smartphone is completed successfully, [PAIRING SUCCESSFUL] is displayed and then a few seconds later the screen returns to the [Bluetooth] settings screen.

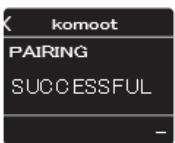

The screenshot shows the 'komoot' menu with 'PAIRING SUCCESSFUL' displayed in large letters. The other options are 'BACK' and a minus sign.

■ Precautions

- Even when following the instructions on a route by the navigation system, do not ignore road signs.
- The navigation system cannot take into account roadworks or temporary diversions.
- Even when using the navigation system, always follow the actual traffic rules.
- Depending on the communications environment, the distance shown by the navigation system may differ from the actual distance.

■ Checking [CERTIFICATION]

- ① Select [CERTIFICATION] from the settings menu, and then press the [information] button.

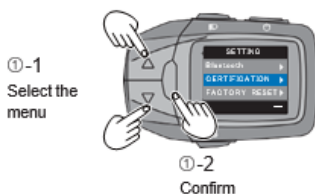

- ② On the [CERTIFICATION] screen, you can check the following details.

- Displays Technical Standards Conformity information for Japan. When you press the [information] button, the screen returns to the [SETTING] screen.

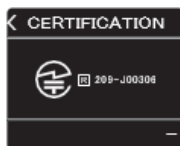

■ Performing a [FACTORY RESET]

- ① Use the assist mode select buttons (▼ ▲) to select [FACTORY RESET], and then press the [information] button.

- [YES]: After restoring the Side Display to factory settings, the system returns to the [SETTING] screen.
- [NO]: The system returns to the [SETTING] screen.

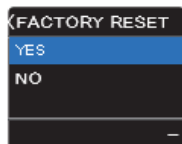

Item	Factory setting
BRIGHTNESS	Day mode: 8 Night mode: 4
LANGUAGE	ENGLISH
UNIT	km km/h
WHEEL	2200
ODO	0
TRIP	0
AVG	0
MAX	0
CPP	Not connected
NAVIGATION	Hidden
komoot	Not connected

Night mode button

Night mode button

Change the backlight brightness of the side display. Backlight setting has a normal mode and night mode. Five stages of brightness can be set for each mode.

In night mode, the brightness is lowered compared to normal mode so that glare can be reduced while travelling at night.

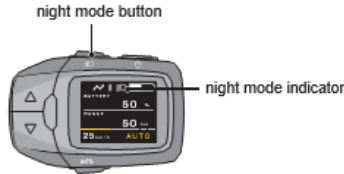

1) Press the power button.

- The electric bicycle system is turned on and the backlight of the side display lights in normal mode.

2) Press the night mode button.

- The night mode indicator is displayed on the side display and the backlight changes to night mode. To change to normal mode, press the night mode button again.

Note

If you set the same brightness for both normal mode and night mode, the brightness does not change even when the mode is switched.

- Set the brightness of the normal mode while the night mode indicator is not displayed. Set the brightness of the night mode while the night mode indicator is displayed. (➔page 9)
- Depending on the specifications of the completed bicycle, if the electric bicycle battery-powered head light or tail lamp is equipped, it will light in night mode.

Charging external devices

Charging external devices using the USB cable (optional)

You can charge external devices (e.g. mobile phones) that can be connected to the console via the USB cable. Connect the exclusive USB cable to charge for three hours.

External devices can be charged only when the side display of the console, and a charged battery are mounted on the electric bicycle. Also, the USB cable (commercially available) compatible with the external device is required.

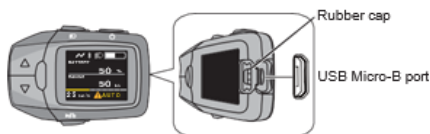

Fig. 1

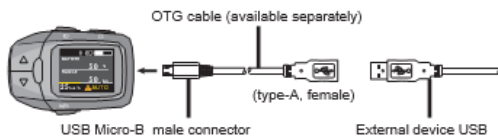

Fig. 2

- 1) Open the cover of the USB Micro-B port on the side display of the console. (Fig. 1)
- 2) Connect a separately purchased USB OTG cable to the USB Micro-B port.
*Charging can only be performed using an OTG cable for USB Micro-B ports.
- 3) Connect the OTG cable and external device's USB cable.
- 4) When the Side Display and external device are connected via a USB cable, charging starts automatically.

Attention

- Do not place the external device on a tilted or unstable place while charging. Doing so may cause the device to fall and result a malfunction.
- Some external devices cannot be charged.
- Back up the internal data on the external device since there is the risk that it may disappear.
- Operation has only been verified with some external devices using the exclusive USB cable. There is no guarantee that your external device will work correctly.
- Do not charge external devices in rainy weather or connect a wet USB cable. Doing so may cause a malfunction.
- After using the USB Micro-B port, firmly close the rubber cap. Otherwise, water may seep in and cause malfunction.
- In order to prevent damage to the USB plug and USB cable, be sure to hold the plug when separating them.
- Do not apply excessive force to the USB plug or pull the USB cable.
- Check that the USB plug is facing the correct direction and has not become detached from the USB Micro-B port and is not misaligned.
- Do not put any foreign objects in the USB Micro-B port. Doing so can cause defects in the Side Display and external device.
- When charging a smartphone or other such device, please give sufficient consideration to safety and do not ride one-handed or look at the screen while riding.
- Charging may not be possible when the battery level is low.
- Please note that in the unlikely event that the contents of the memory of an external device are erased during use of the USB Micro-B port, Panasonic shall accept no responsibility whatsoever.
- Panasonic shall also accept no responsibility concerning damaged caused by malfunctions or other problems resulting from the combination of connected devices.

Error codes

The parts of the electric bicycle system are monitored at all times during use and charging. If an error is detected, an error code will be displayed on the console. To return the console to the standard display, press any button on the side display of the console. Depending on the error code, motor unit drive is automatically stopped as necessary. The assist function will no longer be activated, though travel can be continued.

If the Side Display screen shows any of the following, check the details and take the action described.



■ Errors for which the warning icon is displayed in the bottom center of the screen

- If the warning icon is displayed, the details of the warning are displayed after the CADENCE screen when the [information] button is pressed to switch the display.

*If the navigation function is enabled, the screen changes in the order of CADENCE ⇒ Navigation screen ⇒ Warning screen.







Screen	Solution	Page
	<ul style="list-style-type: none"> • The drive unit is under an excessive load, and the system has entered protected mode. <ul style="list-style-type: none"> ⇨ Reduce speed variation to lighten the load during travel. After a short period of time, the temperature will return to normal and assistance will be restored. • When the system enters protected mode (when using in hot, sunny conditions, etc.), the assistance force is limited. However, you can continue to use your bicycle as normal. If the display does not come back on after a short period of time, please consult your dealer. 	—
	<ul style="list-style-type: none"> • This is an error in communication between the Side Display and the drive unit. <ul style="list-style-type: none"> ⇨ Contact your dealer for repair. 	—
	<ul style="list-style-type: none"> • The battery is under an excessive load, and the system has entered protected mode. <ul style="list-style-type: none"> ⇨ Reduce speed variation to lighten the load during travel. After a short period of time, the temperature will return to normal and assistance will be restored. • When the system enters protected mode (when using in hot, sunny conditions, etc.), the assistance force is limited. However, you can continue to use your bicycle as normal. If the display does not come back on after a short period of time, please consult your dealer. 	—
	<ul style="list-style-type: none"> • Communication with the battery is not being performed correctly. <ul style="list-style-type: none"> ⇨ Clean away any dirt from the battery terminals. If this does not solve the problem, consult your dealer. 	—
	<ul style="list-style-type: none"> • This is an error with the drive unit. <ul style="list-style-type: none"> ⇨ Contact your dealer for repair. 	—

	<ul style="list-style-type: none"> The speed sensor does not correctly detect the signal. ⇨ Turn the device off and then back on. If this does not solve the problem, consult your dealer. 	—
	<ul style="list-style-type: none"> Protection for the USB power supply function is in effect. ⇨ Turn the device off and on again. If this does not solve the problem, this function cannot be used with your device. 	—
	<ul style="list-style-type: none"> If multiple errors occur simultaneously, [W-0] is omitted and the error symbols are displayed in a list. Refer to the relevant error items for details. 	—

■ Other errors

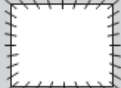
- In the event of an error where assistance or walk assistance cannot be continued, the screen may display the following errors regardless of the warning icon.

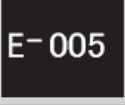
*The errors may be displayed along with the warning icon.

Screen	Solution	Page
	<ul style="list-style-type: none"> If the screen goes completely white when you turn the Side Display on, this means a software error has occurred. ⇨ Contact your dealer for repair. 	—
	<ul style="list-style-type: none"> If the screen flashes white after turning the power on, this means an EEPROM error has occurred. ⇨ Contact your dealer for repair. 	—
	<ul style="list-style-type: none"> Were you standing on the pedal when you pressed the power button? ⇨ Turn the Side Display on by pressing the power button without standing on the pedal. 	—
	<ul style="list-style-type: none"> Original battery (from time of purchase) not detected. ⇨ Load the original battery (from time of purchase). 	—
	<ul style="list-style-type: none"> This is an error in communication between the Side Display and the drive unit. ⇨ Contact your dealer for repair. 	—
	<ul style="list-style-type: none"> This is an error with the drive unit. ⇨ Contact your dealer for repair. 	—
	<ul style="list-style-type: none"> There is a fault in an important component. ⇨ Remove your hand from the bicycle mark button and turn the power on. If this does not solve the problem, contact your dealer for repair. 	—



- This is an error with the drive unit software.
⇒ Contact your dealer for repair.

—

Daily care

The parts of the electric bicycle system are precision parts and must be cared for daily.

Daily care

- Prevent all parts of the electric bicycle system from getting dirty. If parts are dirty, wipe off the dirt with a soft, moist cloth. (Battery terminals and corresponding connectors, and terminals on the cradle and on the side display of the console)
- Before and after use, wipe any dirt or water from the terminals on the console or cradle.

Specifications

■ Console

Operating temperature	-10°C to 40°C
Storage temperature	-20°C to 50°C
Weight	Approx 120 g
Waterproofing level	IPX5
USB output	5 V DC, Max. 1 A
USB port	USB Micro-B
Communication type	Bluetooth version 5.0
Maximum power	8.0 dBm
Communication range	Up to 1 m approx.
Frequency band	2402-2480 MHz
Supported profiles	CPP (*1), komoot (*2)

*1 CPP (Cycling Power Profile)

*2 komoot (supports the komoot app)

Copyright

The Bluetooth® word mark and logo are registered trademarks of Bluetooth SIG, Inc. Panasonic Co., Ltd. uses this mark and logo under license. All other trademarks and registered trademarks are trademarks or registered trademarks of the relevant party.

In addition, the various names, company names, and product names in this manual are trademarks or registered trademarks of the relevant company. Please note that some ™ and ® marks are omitted in this manual.

After-sales service

Check with an authorized bicycle dealer if you have any questions about the electric bicycle system and its components.

Disposal of Old Equipment and Batteries Only for European Union and countries with recycling systems



These symbols on the products, packaging, and/or accompanying documents mean that used electrical and electronic products and batteries must not be mixed with general household waste.

For proper treatment, recovery and recycling of old products and used batteries, please take them to applicable collection points, in accordance with your national legislation.

End-users in Germany are legally obliged to return used batteries to appropriate collection points. Batteries can be returned to retailers free of charge.

In Spain, users are required to deliver batteries to the appropriate collection points. In all cases, this will be free of charge for users. The cost of environmental management of waste batteries and accumulators is included in the sale price.

By disposing of them correctly, you will help to save valuable resources and prevent any potential negative effects on human health and the environment.

For more information about collection and recycling, please contact your local municipality.

Penalties may be applicable for incorrect disposal of this waste, in accordance with national legislation.



Note for the battery symbol (bottom symbol):

This symbol might be used in combination with a chemical symbol. In this case it complies with the requirement set by the Directive for the chemical involved.

Declaration of Conformity (DoC)

Hereby, "Panasonic Cycle Technology Co., Ltd." declares that this product is in compliance with the essential requirements and other relevant provisions of Directive 2014/53/EU.

Customers can download a copy of the original DoC to our RE products from our DoC server:

<https://www.ptc.panasonic.eu/>

Contact to Authorised Representative:

Panasonic Marketing Europe GmbH, Panasonic Testing Centre,
Winsbergring 15, 22525 Hamburg, Germany

Manufactured by:

Panasonic Cycle Technology Co., Ltd.
13-13 Katayama-cho, Kashiwara City, Osaka 582-8501, Japan

Authorized Representative in Europe:

Panasonic Marketing Europe GmbH
Panasonic Testing Centre
Winsbergring 15, 22525 Hamburg, Germany

Maintenance

Regular maintenance:

- maintain all components of the electric bicycle clean
- use only the recommended and tested cleaning materials
- regularly lubricate the chain with suitable oils
- in winter, clean the electric bicycle after each ride and pay increased attention to removing salt from battery contacts and other connectors
- while handling the electric bicycle, make sure the cables of the electric system are not damaged. Damaged cables pose a risk of electric shock
- regularly check all connections for correct tightening and brakes for correct function. Check also individual parts of the electric bicycle for damage. For example: cracks on the frame, fork, handlebars, stem, damage to cables, damage to battery pack, etc.

Battery transport:

Battery transport is subject to the requirements of regulations on dangerous goods. Private users may transport undamaged batteries on roads without having to conform to other conditions.

In case of transport by commercial users or by third parties it is necessary to comply with special packaging and marking requirements (e.g. ADR regulations)

Batteries should only be sent if the battery pack is undamaged. Plug loose contacts and pack the battery to prevent its movement in the packaging. Notify the forwarding service that the transport concerns dangerous goods.

Battery storage:

Store the battery in a dry and well-ventilated place, out of reach of direct sunlight and other heat sources. In case of cold storage it is necessary to let the battery warm up to normal room temperature (20°C) before putting into operation.

Never leave the battery fully discharged. It could result in its permanent damage. For long-term storage keep the battery fully charged. However, do not store it while permanently connected to the charger or installed in the electric bicycle.

Li-Ion batteries are fully recyclable. After expiry of the battery life you can return it at any collection point or your dealer.

If you use an e-bike in hard conditions (long-term use of the maximum assistance), for longer ride at higher temperatures (30 ° C or above), in direct sunlight or when the battery is partially discharged and a combination of these situations is it possible that bike will automatically switch off. This is a fuse protecting the control unit against burning. We recommend stop the ride and let the bike (control unit) cool down little bit. This is not a defect.

Electric set warranty



Complaint procedure:

Submit any complaints concerning the electric set or the battery to your dealer.

When filing a complaint, submit a proof of purchase and a warranty certificate with the registered serial number of the battery and indicate the reason for the complaint and a description of the defect.

Warranty conditions:

24 months for electric bicycle components – applies to manufacturing and material defects beyond normal wear and tear caused by use.

12 months for battery life – the nominal battery capacity does not drop below 70 % of the total capacity over 12 months from the sale of the electric bicycle.

Warranty conditions:

The electric set must be used exclusively for the purposes it is intended for.

The electric set must be used, stored and maintained in accordance with these Operating Instructions.

A warranty claim shall expire:

If it is found out that the damage to the product is due to the user's fault (accident, inexpert handling beyond the framework of these Operating Instructions, tampering with the structure of the electric bicycle or connection of the electric system, improper storage etc.).

Expiry of the warranty period.

The warranty only applies to the first owner

Warning

If you do not understand any of the points in these Operating Instructions, please contact the dealer for explanation. Please read the whole manual!

Do not lend the e-bike to persons not briefed in its use and operation. Complaints resulting from improper handling will not be accepted.

The LF Energy electric bicycle is not intended for use by children under 15 years of age. Likewise, the electric bicycle cannot be used by persons unable to pedal or handle it independently. The manufacturer is not to be held responsible for any potential injuries or damage to the bicycle!

Ideal weather conditions for using an electric bicycle are dry days, when the outdoor temperature is above 10°C. When used at lower temperatures, the battery discharges faster due to physical phenomena. Using the electric bicycle at temperatures below 0°C is not recommended.

Do not expose the bicycle to direct sunlight as it is fitted with a protective temperature sensor for the electric motor.

Never submerge the battery, the charger and other electric components in water or another liquid.

Never wash the electric bicycle in a pressure washer (WAP) and always remove the battery before washing

It is forbidden to tamper with the connections of the electric motor, the control unit and the battery. Violating this section may result in the warranty not being acknowledged or in irreversible damage to the electric bicycle.

DO NOT USE chargers and components other than the ones included with the electric bicycle.

We cannot be held responsible for damage caused by use of other non-approved goods

LEADER FOX



Enjoy many pleasant and safe kilometres on your new electric bicycle.

Your Leader Fox Team



**Czech brand of electric bicycles.
BOHEMIA BIKE**

Address

Pujmanové 1753/10a, Nusle
140 00 Praha 4

Development, design and manufacturing

Okružní 697
České Budějovice 37001

Phone: 388 314 885

Email: info@leaderfox.cz

