

7 DEALER MANUAL FOR DP C241.CAN



CONTENT

| | | | |
|--|---|--|----|
| 7.1 Important Notice | 2 | 7.7.3 Selection Mode..... | 6 |
| 7.2 Introduction of Display | 2 | 7.7.4 Headlights / backlighting..... | 7 |
| 7.3 Product Description | 3 | 7.7.5 Walk Assistance..... | 7 |
| 7.3.1 Specifications..... | 3 | 7.7.6 BOOST Function..... | 8 |
| 7.3.2 Functions Overview..... | 3 | 7.7.7 Battery Capacity Indication..... | 8 |
| 7.4 Display Installation | 4 | 7.7.8 USB Charge Function..... | 8 |
| 7.5 Display | 5 | 7.7.9 Bluetooth Function..... | 8 |
| 7.6 Key Definition | 5 | 7.8 Settings | 9 |
| 7.7 Normal Operation | 6 | 7.8.1 "Display Setting"..... | 9 |
| 7.7.1 Switching the System ON/OFF..... | 6 | 7.8.2 "Information"..... | 11 |
| 7.7.2 Selection of Support Levels..... | 6 | 7.9 Error Code Definition | 13 |

7.1 IMPORTANT NOTICE

- If the error information from the display cannot be corrected according to the instructions, please contact your retailer.
- The product is designed to be waterproof. It is highly recommended to avoid submerging the display under water.
- Do not clean the display with a steam jet, high-pressure cleaner or water hose.
- Please use this product with care.
- Do not use thinners or other solvents to clean the display. Such substances can damage the surfaces.
- Warranty is not included due to wear and normal use and aging.

7.2 INTRODUCTION OF DISPLAY

- Model: DP C241.CAN BUS
- The housing material is PC; the display windows is made of ACRYLIC material:
- The label marking is as follows:



-  **Note:** Please keep the QR code label attached to the display cable. The information from the Label is used for a later possible software update.

7.3 PRODUCT DESCRIPTION

7.3.1 Specifications

- Operating temperature: -20 °C~45 °C
- Storage temperature: -20 °C~50 °C
- Waterproof: IP65
- Storage room Humidity: 30%-70% RH

7.3.2 Functional Overview

- Speed indication (including the real-time speed, max. speed and average speed)
- Unit switching between km and mile
- Battery capacity indicator
- Automatic sensors explanation of the lighting system
- Brightness setting for backlight
- Indication of performance support
- Kilometer stand (including single-trip distance, total distance and remaining distance)
- BOOST function (NOTE: it needs the controller has this function)
- Indication of power assistance level
- Time indication for ride
- Input power of motor indication
- Walk assistance
- Indication for error messages
- Indication for consumption of energy CALORIES (NOTE: If the controller has this function)
- Indication for the remaining distance. (NOTE: it needs the controller has this function)
- Button vibration setting
- USB charging (5V and 500mA)
- Dual Bluetooth communication function

7.4 DISPLAY INSTALLATION

1. Tighten the bracket onto the display with three M2*4 screws.
(A. display, B. bracket, C. M2 screw.)

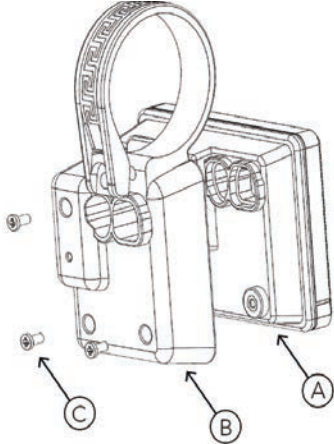

2. Open the clamps of controller panel and place it on to the handlebar in the correct position. Now with M4*12 screws (A) tighten the controller panel onto position. Torque requirement: 1N.m.

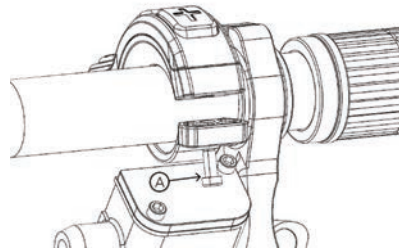

3. Link the cable from controller panel (B) and the cable from E-Bus (A) onto the display.

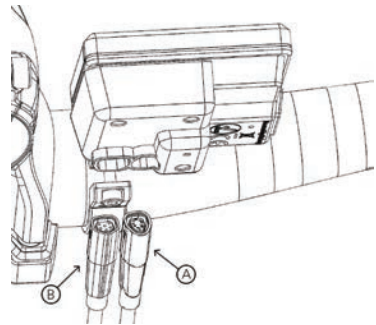

1. Open the clamps of display and place the display on to the handlebar in the correct position. Now with M3*14 screws (A) tighten the display into position. Torque requirement: 0.3N.m.

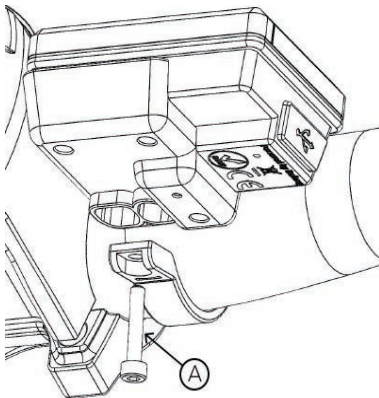

7.5 DISPLAY

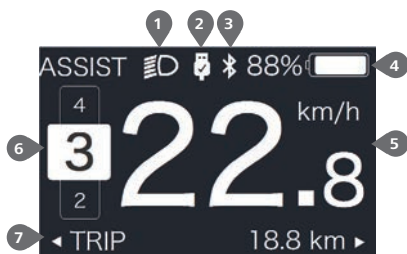



- 1 Headlight indication
- 2 USB connection indication
- 3 Bluetooth indicator
- 4 Battery capacity indication
- 5 Speed display in real-time
- 6 Assistance level indication
- 7 Multiple data indication

7.6 KEY DEFINITION



7.7 NORMAL OPERATION



7.7.1 Switching the System ON/OFF

Press  and hold (>2S) to power on the display, the HMI begin to show the boot up LOGO. Press  and hold (>2S) again can power off the HMI.

If the "automatic shutdown" time is set to 5 minutes (it can be set in function "Auto Off"), the HMI will be automatically turned off within this set time, When it is not operated.



7.7.2 Selection of Support Levels

When HMI power on, briefly press  or  to select the assistance level (the number of assistance level needs to be adapted to controller), The lowest level is Level 0, the highest Level is 5. On the default is Level 1, "0" means no power assistance. The interface is as following:



Note: if the controller has Boost function, can be selected this level with briefly press .

7.7.3 Selection Mode

Briefly press  button to view the different mode and information.

1. System with torque sensor, circularly show single trip distance (TRIP,km) → total distance (ODO,km) → maximum speed (MAX,km/h) → average speed (AVG,km/h) → remaining distance (RANGE,km) → energy consumption (CALORIES/CAL,KCal) → real-time output power (POWER,w) → riding time (TIME,min).
2. If system with a speed sensor, circularly show single trip distance (Trip,km) → total distance (ODO,km) → maximum speed (MAX,km/h) → average speed (AVG,km/h) → remaining distance (RANGE,km) → riding time (TIME,min).



7.7.4 Headlights / backlighting



Press and hold **+** (>2S) to turn on the backlight as well as headlight.

Press and hold **+** (>2S) again to turn off the backlight and the headlight. The brightness of backlight can be set in function "Brightness". (If the display is turned on in a dark environment, the display backlight/ headlight will be turned on automatically. If the display backlight/headlight are turned off manually, they also need to be turned on manually afterwards)





7.7.5 Walk Assistance

The Walk assistance can only be activated with a standing pedelec.

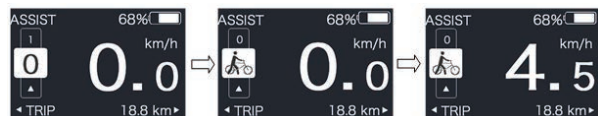
Activation: briefly press **+** button until this symbol  appears. Next hold down the **+** button whilst the  symbol is displayed. Now the Walk assistance will activate. The symbol will flash and the pedelec moves approx. 6 km/h. After releasing the **+** button the motor stops automatically and if no any operations within 5s will automatically return to 0 level (as following).



7.7.6 BOOST Function

In riding, when speed is arrived 25km/h, can select in BOOST level, at this point press  button and hold (>2S), then the Pedelec enters in BOOST function. The indicator  on display will flash and the motor output with max. power. (BOOST function as following). If release the button or do any other operation will stop BOOST.

NOTE: If the speed is not arrived 25km/h, this function can not be implemented and press  button and hold (>2S) the HMI can powered off.



7.7.7 Battery Capacity Indication

The percentage of current battery capacity and total capacity is displayed from 100% to 0% according to the actual capacity (as shown in the figure below)

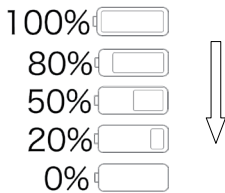

7.7.8 USB Charge Function

When the HMI is off, insert the USB device to the USB charging port on the HMI, and then turn on HMI to charge. When the HMI is on, can direct charge for USB device. the maximum charging voltage is 5V and the maximum charging current is 500mA.

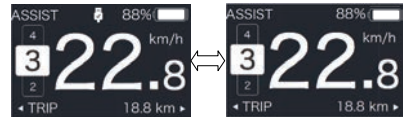

7.7.9 Bluetooth Function

This display can be connected to the Bafang Go APP through Bluetooth.

This display can be connected to the SIGMA heartbeat band and shows it on display, and can also send data to the mobile phone.

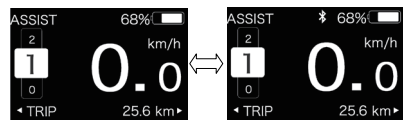

7.8 SETTINGS

After the HMI powered on, press and hold **+** and **-** button (at the same time) to enter into the setting interface. Briefly press (<0.5S) **+** or **-** button to select "Setting", "Information" or "Exit", then briefly press (<0.5S) **⏻** button to confirm.

- Setting
- Information
- Exit

You can press and hold **+** and **-** button at any time, to return to the main screen.

7.8.1 "Setting" interface

After the HMI powered on, press and hold **+** and **-** button to enter into the setting interface. Briefly press (<0.5S) **+** or **-** to select "Setting" and then briefly press **⏻** (<0.5S) to confirm.

- Unit
- Auto Off
- Brightness
- Power View
- AI Sensitivity

- Trip Reset
- Vibration
- Service
- Assist Mode
- Back

7.8.1.1 "Unit" Selections in km/Miles

Briefly press **+** or **-** to select "Unit", and briefly press **⏻** to enter into the item. Then choose between "Metric" (kilometer) or "Imperial" (Miles) with the **+** or **-** button. Once you have chosen your desired selection, press the **⏻** button (<0.5S) to save and exit back to the "Setting" interface.

| | |
|--------|----------|
| Unit | Unit |
| Metric | Imperial |

7.8.1.2 "Auto Off" Set automatic Off time

Briefly press **+** or **-** to select "Auto Off", and briefly press **⏻** to enter into the item. Then select the automatic Off time as "OFF" / "9" / "8" / "7" / "6" / "5" / "4" / "3" / "2" / "1" with the **+** or **-** button. Once you have chosen your desired selection, press the **⏻** button (<0.5S) to save and exit back to the "Setting" interface.

Notice: "OFF" means this function is off, the unit is minute.

| | | |
|----------|----------|----------|
| Auto Off | Auto Off | Auto Off |
| 9 | 1 | OFF |

7.8.1.3 "Brightness" Display brightness

Briefly press **+** or **-** to select "Brightness", and briefly press **⏻** to enter into the item. Then select the percentage as "100%" / "75%" / "50%" / "30%" / "10%" with the **+** or **-** button. Once you have chosen your desired selection, press the **⏻** button (<0.5S) to save and exit back to the "Setting" interface.

Notice: "10%" is the weakest brightness and 100%" is the strongest brightness.

| | | |
|------------|------------|------------|
| Brightness | Brightness | Brightness |
| 100% | 75% | 50% |
| Brightness | Brightness | |
| 30% | 10% | |





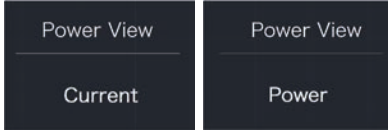

7.8.1.4 "Power View" Set output display mode

Briefly press **+** or **-** to select "Power View", and briefly press **⏻** to enter into the item. Then select the output display mode as "Power" / "Current" with the **+** or **-** button.

Once you have chosen your desired selection, press the  button (<0.5S) to save and exit back to the "Setting" interface.







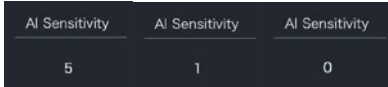

7.8.1.5 "AL Sensitivity" Set light sensitivity

Briefly press  or  to select "AL Sensitivity", and briefly press  to enter into the item. Then select the level of the light sensitivity as "0"/"1"/"2"/"3"/"4"/"5" with the  or  button. Once you have chosen your desired selection, press the  button (<0.5S) to save and exit back to the "Setting" interface.

Notice: "0" means light sensor is off. Level 1 is the weakest sensitivity and level 5 is the strongest sensitivity.







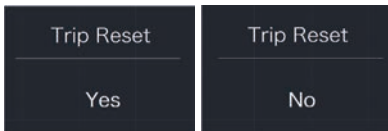

7.8.1.6 "TRIP Reset" Set reset function for single-trip

Briefly press  or  to select "AL Sensitivity", and briefly press  to enter into the item. Then select "NO"/"YES" ("YES" - to clear, "NO"-no operation) with the  or  button. Once you have chosen your desired selection, press the  button (<0.5S) to save and exit back to the "Setting" interface.

Notice: The riding time(TIME), average speed (AVG) and maximum speed (MAXS) will be reset simultaneously when you reset TRIP.







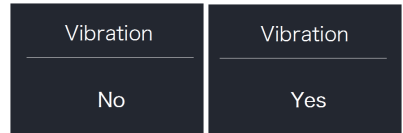

7.8.1.7 "Vibration" Set the button vibration

Briefly press  or  to select "Vibration", and briefly press  to enter into the item. Then select "NO"/"YES" ("YES" means vibration button is on; "NO" means vibration button is off) with the  or  button. Once you have chosen your desired selection, press the  button (<0.5S) to save and exit back to the "Setting" interface.







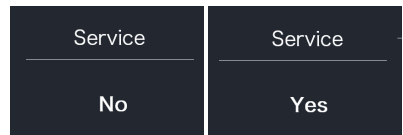

7.8.1.8 "Service" Turn on/off the Service indication

Briefly press  or  to select "Service", and briefly press  to enter into the item. Then select "NO"/"YES" ("YES" means Service indication is on; "NO" means Service indication is off) with the  or  button. Once you have chosen your desired selection, press the  button (<0.5S) to save and exit back to the "Setting" interface.



7.8.1.9 "Assist Mode"---set the assist level

Briefly press  or  to select "Assist Mode", and briefly press  to enter into the item. Then select the assistance level as "3"/"5"/"9" with the  or  button. Once you have chosen your desired selection, press the  button (<0.5S) to save and exit back to the "Setting" interface.

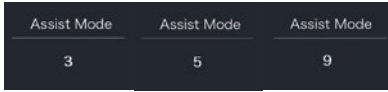

7.8.2 "Information"

After the HMI powered on, press and hold **+** and **-** to enter into the setting function. Briefly press (<0.5S) **+** or **-** to select "Information" and then briefly press **⏻** (<0.5S) to confirm.

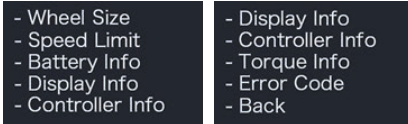

Note: All information here cannot be changed, it is to be viewed only.

7.8.2.1 "Wheel Size"

Briefly press **+** or **-** to select "Wheel Size", and then briefly press **⏻** to view the wheel size default.

Press the **⏻** button (<0.5S) to exit back to the "Information" interface.

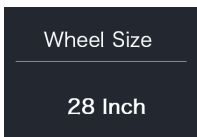

7.8.2.2 "Speed Limit"

Briefly press **+** or **-** to select "Speed Limit", and then briefly press **⏻** to view the speed limit default.

Press the **⏻** button (<0.5S) to exit back to the "Information" interface.

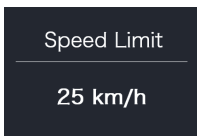

7.8.2.3 "Battery Info"

Briefly press **+** or **-** to select "Battery Info", and briefly press **⏻** to enter, then briefly press **+** or **-** to view the battery data (b01 → b04 → b06 → b07 → b08 → b09 → b10 → b11 → b12 → b13 → d00 → d01 → d02 → ... → dn → Hardware Ver → Software Ver).

Press the **⏻** button (<0.5S) to exit back to the "Information" interface.

Notice: If the battery doesn't have communication function, you won't see any data from battery.

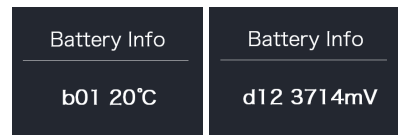

View the battery information

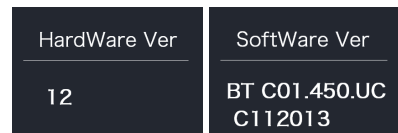

View the hardware and software version of battery

| Code | Code Definition | Unit |
|------|----------------------------------|------|
| b01 | Current temperature | °C |
| b04 | Battery voltage | mV |
| b06 | Current | mA |
| b07 | Remaining battery capacity | mAh |
| b08 | Battery capacity of Full charged | mAh |
| b09 | Relative SOC | % |
| b10 | Absolute SOC | % |

| Code | Code Definition | Unit |
|--------------|--------------------------|-------|
| b11 | Cycle Times | times |
| b12 | Max Uncharge Time | Hour |
| b13 | Last Uncharge Time | Hour |
| d00 | The number of cell | |
| d01 | Voltage Cell 1 | mV |
| d02 | Voltage Cell 2 | mV |
| dn | Voltage Cell n | mV |
| Hardware Ver | Battery Hardware Version | |
| Software Ver | Battery Software Version | |

NOTE: If no data is detected, "--" will be displayed.

7.8.2.4 "Display Info"

Briefly press **+** or **-** to select "Display Info", and briefly press **↵** to enter, briefly press **+** or **-** to view "Hardware Ver" or "Software Ver".

Press the **↵** button (<0.5S) to exit back to the "Information" interface.

| HardWare Ver | SoftWare Ver |
|---------------|------------------|
| DP C240.C 2.0 | DPC240CI1020 2.0 |

7.8.2.5 "Ctrl Info"

Briefly press **+** or **-** to select "Ctrl Info", and briefly press **↵** to enter, briefly press **+** or **-** to view "Hardware Ver" or "Software Ver".

Press the **↵** button (<0.5S) to exit back to the "Information" interface.

| HardWare Ver | SoftWare Ver |
|-----------------|-----------------------|
| X10B.350.FC 1.0 | CRX10BC4313 E101003.0 |

7.8.2.6 "Torque Info"

Briefly press **+** or **-** to select "Torque Info", and briefly press **↵** to enter, briefly press **+** or **-** to view "Hardware Ver" or "Software Ver".

Press the **↵** button (<0.5S) to exit back to the "Information" interface.

| HardWare Ver | SoftWare Ver |
|-----------------------|-------------------|
| SR PA212.32. ST.C 1.0 | SRPA212CF1 0101.0 |

NOTE: If your Pedelec doesn't have torque sensor, "--" will be displayed.

7.8.2.7 "Error Code"

Briefly press **+** or **-** to select "Error Code", and then briefly press **↵** to enter, briefly press **+** or **-** to view message of error for last ten times by "E-Code00" to "E-Code09". Press the **↵** button (<0.5S) to exit back to the "Information" interface.

NOTE: 00 means no error exist.

| Error Code | Error |
|-------------|-------|
| E-Code00 30 | 30 |

7.9 ERROR CODE DEFINITION

 The HMI can show the faults of Pedelec. When a fault is detected, one of the following error codes will be indicated too.

Note: Please read carefully the description of the error code. When the error code appears, please first restart the system. If the problem is not eliminated, please contact your dealer or technical personnel.

| Error | Declaration | Troubleshooting |
|-------|--|---|
| 04 | The throttle has fault. | <ol style="list-style-type: none"> 1. Check the connector and cable of the throttle are not damaged and correctly connected. 2. Disconnect and reconnect the throttle, if still no function please change the throttle. |
| 05 | The throttle is not back in its correct position. | Check the connector from the throttle is correctly connected. If this does not solve the problem, please change the throttle. |
| 07 | Overvoltage protection | <ol style="list-style-type: none"> 1. Remove and re-Insert the battery to see if it resolves the problem. 2. Using the BESST tool update the controller. 3. Change the battery to resolve the problem. |
| 08 | Error with the hall sensor signal inside the motor | <ol style="list-style-type: none"> 1. Check all connectors from the motor are correctly connected. 2. If the problem still occurs, please change the motor. |
| 09 | Error with the Engine phase's | Please change the motor. |
| 10 | The temperature inside the engine has reached its maximum protection value | <ol style="list-style-type: none"> 1. Turn off the system and allow the Pedelec to cool down. 2. If the problem still occurs, please change the motor. |
| 11 | The temperature sensor inside the motor has an error | Please change the motor. |
| 12 | Error with the current sensor in the controller | Please change the controller or contact your supplier. |

| Error | Declaration | Troubleshooting |
|-------|---|---|
| 13 | Error with the temperature sensor inside of the battery | <ol style="list-style-type: none"> 1. Check all connectors from the battery are correctly connected to the motor. 2. If the problem still occurs, please change the Battery. |
| 14 | The protection temperature inside the controller has reached its maximum protection value | <ol style="list-style-type: none"> 1. Allow the pedelec to cool down and restart the system. 2. If the problem still occurs, please change the controller or contact your supplier. |
| 15 | Error with the temperature sensor inside the controller | <ol style="list-style-type: none"> 1. Allow the pedelec to cool down and restart the system. 2. If the problem still occurs, Please change the controller or contact your supplier. |
| 21 | Speed sensor Error | <ol style="list-style-type: none"> 1. Restart the system 2. Check that the magnet attached to the spoke is aligned with the speed sensor and that the distance is between 10 mm and 20 mm. 3. Check that the speed sensor connector is connected correctly. 4. Connect the pedelec to BESST, to see if there is a signal from the speed sensor. 5. Using the BESST Tool- update the controller to see if it resolves the problem. 6. Change the speed sensor to see if this eliminates the problem. If the problem still occurs, please change the controller or contact your supplier. |
| 25 | Torque signal Error | <ol style="list-style-type: none"> 1. Check that all connections are connected correctly. 2. Please connect the pedelec to the BESST system to see if torque can be read by the BESST tool. 3. Using the BESST Tool update the controller to see if it resolves the problem, if not please change the torque sensor or contact your supplier. |

| Error | Declaration | Troubleshooting |
|-------|--|---|
| 26 | Speed signal of the torque sensor has an error | <ol style="list-style-type: none"> 1. Check that all connections are connected correctly. 2. Please connect the pedelec to the BESST system to see if speed signal can be read by the BESST tool. 3. Change the Display to see if the problem is solved. 4. Using the BESST Tool update the controller to see if it resolves the problem, if not please change the torque sensor or contact your supplier. |
| 27 | Overcurrent from controller | Using the BESST tool update the controller. If the problem still occurs, please change the controller or contact your supplier. |
| 30 | Communication problem | <ol style="list-style-type: none"> 1. Check all connections on the pedelec are correctly connected. 2. Using the BESST Tool run a diagnostics test, to see if it can pinpoint the problem. 3. Change the display to see if the problem is solved. 4. Change the EB-BUS cable to see if it resolves the problem. 5. Using the BESST tool, re-update the controller software. If the problem still occurs please change the controller or contact your supplier. |
| 33 | Brake signal has an error (If brake sensors are fitted) | <ol style="list-style-type: none"> 1. Check all connectors are correctly connected on the brakes. 2. Change the brakes to see if the problem is solved. <p>If problem continues Please change the controller or contact your supplier.</p> |
| 35 | Detection circuit for 15V has an error | Using the BESST tool update the controller to see if this resolves the problem. If not, please change the controller or contact your supplier. |
| 36 | Detection circuit on the keypad has an error | Using the BESST tool update the controller to see if this resolves the problem. If not, please change the controller or contact your supplier. |

| Error | Declaration | Troubleshooting |
|-------|--|--|
| 37 | WDT circuit is faulty | Using the BESST tool update the controller to see if this resolves the problem. If not, please change the controller or contact your supplier. |
| 41 | Total voltage from the battery is too high | Please change the battery. |
| 42 | Total voltage from the battery is too low | Please Charge the battery. If the problem still occurs, please change the battery. |
| 43 | Total power from the battery cells is too high | Please change the battery. |
| 44 | Voltage of the single cell is too high | Please change the battery. |
| 45 | Temperature from the battery is too high | Please let the pedelec cool down. If problem still occurs, please change the battery. |
| 46 | The temperature of the battery is too low | Please bring the battery to room temperature. If the problem still occurs, please change the battery. |
| 47 | SOC of the battery is too high | Please change the battery. |
| 48 | SOC of the battery is too low | Please change the battery. |
| 61 | Switching detection defect | 1. Check the gear shifter is not jammed. 2. Please change the gear shifter. |
| 62 | Electronic derailleur cannot release. | Please change the derailleur. |
| 71 | Electronic lock is jammed | 1. Using the BESST tool update the Display to see if it resolves the problem. 2. Change the display if the problem still occurs, please change the electronic lock. |
| 81 | Bluetooth module has an error | Using the BESST tool, re-update the software onto the display to see if it resolves the problem. If not, Please change the display. |