

Operating Instructions

Side display

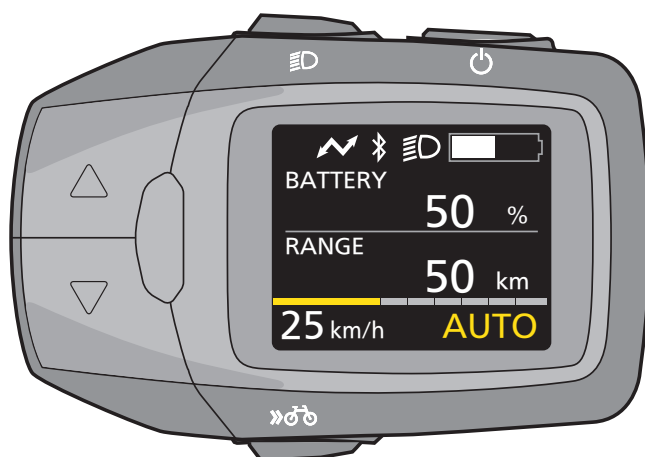

- Before operating this product, please read the instructions carefully and save this manual for future use.
- Before using this product, be sure to read “Read this first!”
- Electric bicycles (Electric Power Assisted Cycles) as used in this manual mean Pedelec.

ENGLISH



Read this first!

For Your Safety



To reduce the risk of injury, loss of life, electric shock, fire, malfunction, and damage to equipment or property, always observe the following safety precautions.

Explanation of symbols

The following symbols are used to classify and describe the level of hazard, injury, and property damage caused when the warning is disregarded and improper use is performed.

	DANGER	Denotes a potential hazard that will result in serious injury or death.
	WARNING	Denotes a potential hazard that could result in serious injury or death.
	CAUTION	Denotes a hazard that could result in minor injury or damage to the unit or other equipment.

The following symbols are used to classify and describe the type of instructions to be observed.



	This symbol is used to alert users to a specific operating procedure that must not be performed.
	This symbol is used to alert users to a specific operating procedure that must be followed in order to operate the unit safely.



■ Console

	<p>Do not modify or disassemble the console.</p> <p>Do not use or leave the console lying around in high temperatures.</p> <ul style="list-style-type: none">• This may cause damage or heat, which may lead to fire. <p>Do not use the bicycle mark button (Walk assistance) when the wheels of the electric bicycles are not in contact with the ground.</p> <ul style="list-style-type: none">• It may cause injury. <p>If a problem occurs when charging a USB device, disconnect the USB cable. (Smoke is emitted, a strange smell or noise is present, the console or the USB cable is damaged, or water gets inside the device.)</p> <ul style="list-style-type: none">• Continued use in such circumstances can cause fire and electric shocks. (Switching the device on/off, assist mode switching, light operation, etc.)• If assistance deactivates when on a slope, when setting off, or due to erroneous operation, you may suffer an injury due to losing your balance or falling over due to riding one-handed.
---	---

■ Bluetooth

	<p>Do not use the device near automatic doors, fire alarms, or other such automatic control devices.</p> <ul style="list-style-type: none">• Radio waves emitted by this device may interfere with automatic control devices, and this may result in accidents due to malfunction. <p>Do not use the device in hospitals or in places where electronic medical devices are present.</p> <ul style="list-style-type: none">• Radio waves emitted by this device may interfere with electronic medical devices, and this may result in accidents due to malfunction.
	<p>Keep this device at least 15 cm away from the part of the body where a cardiac pacemaker is in place if you wear one.</p> <ul style="list-style-type: none">• Radio waves emitted by this device may interfere with the operation of your pacemaker.



CAUTION

■ Console



When the electric bicycle is walked along while the Bicycle mark button (Walk assistance) is pressed, the pedals will still rotate.

- Please be careful as injuries can occur.

Do not use smartphones, cellphones, or other such devices when riding.

- Doing so may lead to injury through accidents.

Do not stare at the screen when riding.

- Doing so may lead to injury through accidents.

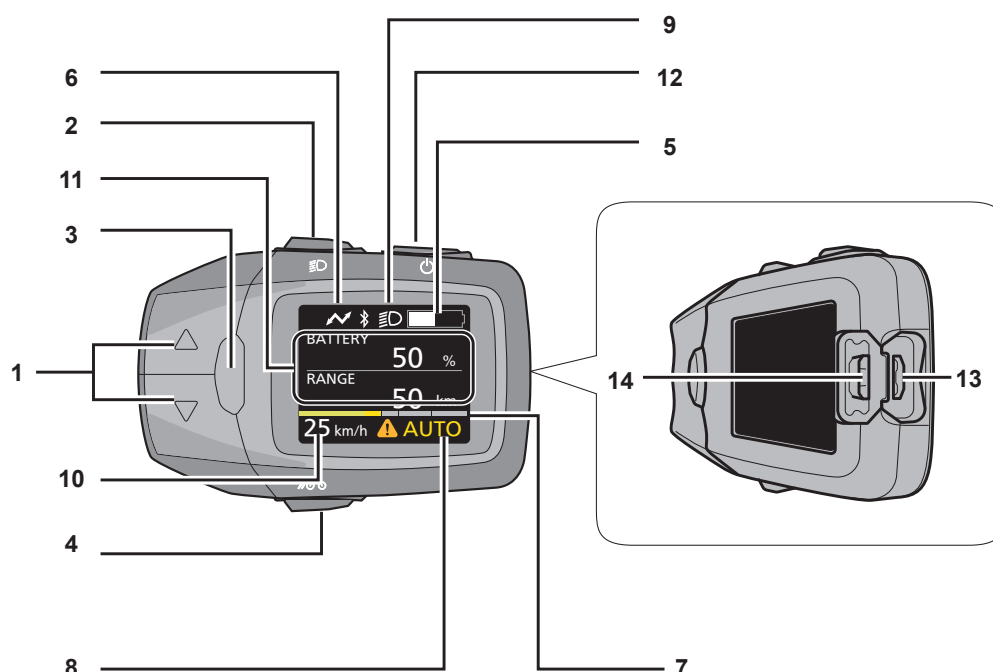

1 Assist mode select buttons (▲/▼)

Selects the assist mode from [HIGH], [STD], [ECO], [OFF] and [AUTO].

2 Night mode button

Lights the backlight of the side display.

When power is supplied to the head light or tail lamp from the battery on the electric bicycle, the head lamp or tail lamp lights. It depends on local regulation. (➔ page 19)

3 information button

Switches display items such as distance traveled.

(➔ page 8)

4 Bicycle mark button (Walk assistance)

Drive can be assisted up to 6 km/h when pushing the electric bicycle with a heavy load on it.

5 Battery level display

Displays the battery remaining capacity.

6 USB connection mark

Displayed when an external device (e.g. mobile phone) is connected to the side display for charging.

7 Assist power indicator

Displays in the form of a graph how much the rider is being assisted. The larger the number on the graph, the more the rider is being assisted.

8 Text indication

Displays the current assist mode, etc.

9 Night mode indicator

Lights when the night mode button is pressed.

10 Speed indication

Displays the current travel speed.

11 Value indication

Displays distance traveled, total distance traveled, maximum speed, etc.

12 Power button

Turns on and off the electric bicycle system.

13 USB Micro-B port

Used to charge an external device (e.g. mobile phone).

(➔ page 20)

14 Rubber cap

Protects the USB Micro-B port.

Mounting the side display of the console

Insert the side display on the band mounted on the handlebar of the electric bicycle.

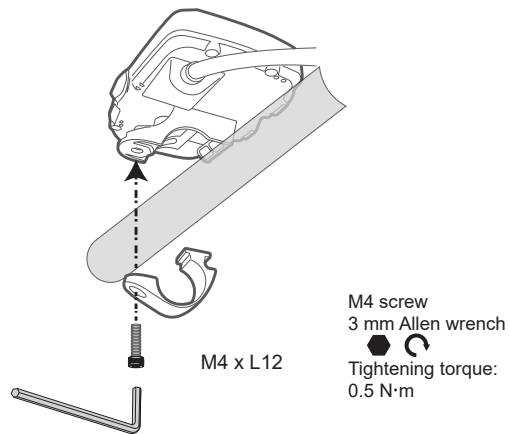

Methods of Use

To enable the assist function or display the various indications, press the power button on the console to turn on the electric bicycle system.

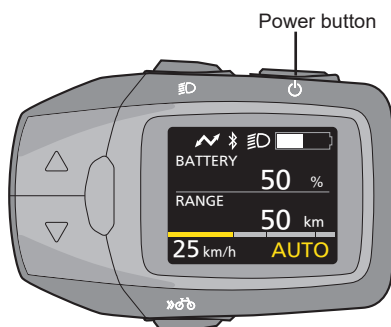

Turning on the electric bicycle system

Press the power button on the side display.

- The system starts with “OFF”, unless the bicycle maker prepared it to an assist function. To change the assist mode, refer to page 7.

Attention

- Before pressing the power button, do not place your feet on the pedals of the electric bicycle. Otherwise, this will result in a torque sensor error or weak assist force.
Press the power button again without placing your feet on the pedals.
- While pressing the power button, do not press any other buttons, otherwise an error may be displayed.
In this case press the power button again without your feet on the pedals.
- Do not turn on/off the power button during riding. If the assist function is not required, press the assist mode select buttons (▲/▼) to select [OFF].

Note

- The assist function of the electric bicycle will not work in the following cases:
 - When you stop pedalling
 - When a speed of 25 km/h is reached (The assist function starts to work by starting pedalling again at 25 km/h or less.)
 - When there is no remaining battery power

Turning off the electric bicycle system

Press the power button on the console when the electric bicycle system is turned on.

Note

- Even if the power button is not pressed to turn off the electric bicycle system, the power automatically turns off to save energy if the electric bicycle is not used for about ten minutes (for example, when the electric bicycle is parked).

Console

Use the buttons on the Side display to change the assist mode. This is shown as well as the remaining capacity of the bicycle battery in the side display.

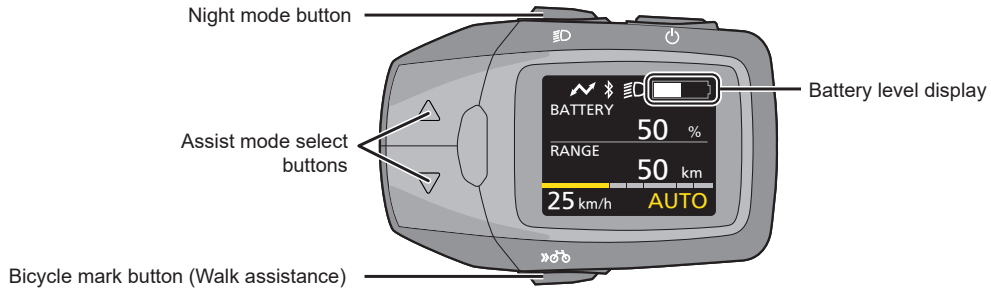

Battery level display

The battery charge status indicates the remaining capacity of the battery in the electric bicycle. The charged state of the battery on the electric bicycle can also be checked by the battery LED.

Side Display LCD screen display	Battery level (%)				Guide
	20	40	60	80	
Display full 	91% - 100%				<p>Ride assistance available</p> <p>When you turn the side display on after charging it, the battery level display will decrease in increments of 1/10. The percentage display for battery level will decrease in increments of 1%.</p>
Display 9/10 full 	81% - 90%				
Display 8/10 full 	71% - 80%				
Display 7/10 full 	61% - 70%				
Display 6/10 full 	51% - 60%				
Display 5/10 full 	41% - 50%				
Display 4/10 full 	31% - 40%				
Display 3/10 full 	21% - 30%				
Display 2/10 full 	11% - 20%				
Display 1/10 full and red 	0% - 10%				
Display empty with diagonal line 	0%				<p>Charging required notification</p> <p>Assist force may gradually decrease.</p>
OFF: Assistance stopped					<p>Ride assistance stopped</p> <p>The battery needs to be charged. If it is not charged, you can ride the bicycle unassisted.</p>

Assist mode select buttons

The five assist modes can be selected by pressing the assist mode select buttons.

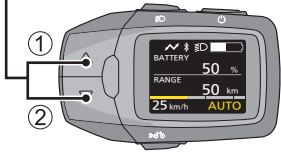
Assist mode select buttons	Assist Mode	
		<p>[HIGH] *1On flat and uphill roads, a powerful assist force is provided for a comfortable ride on slopes and carrying heavy loads.</p> <p>① ↓ ↑ ②</p> <p>[AUTO] *1Depending on road conditions, the assist force automatically changes from low to powerful.</p> <p>① ↓ ↑ ②</p> <p>[STD] *1On flat and uphill roads, a mid assist force is provided.</p> <p>① ↓ ↑ ②</p> <p>[ECO] *1On flat and uphill roads, a low assist force is provided allowing for a longer distance traveled by a single charge.</p> <p>① ↓ ↑ ②</p> <p>[OFF] *1No assist force.</p>

*1 The assist force may change depending on weather conditions, road conditions, bicycle conditions, or riding styles.

• Change in assist force

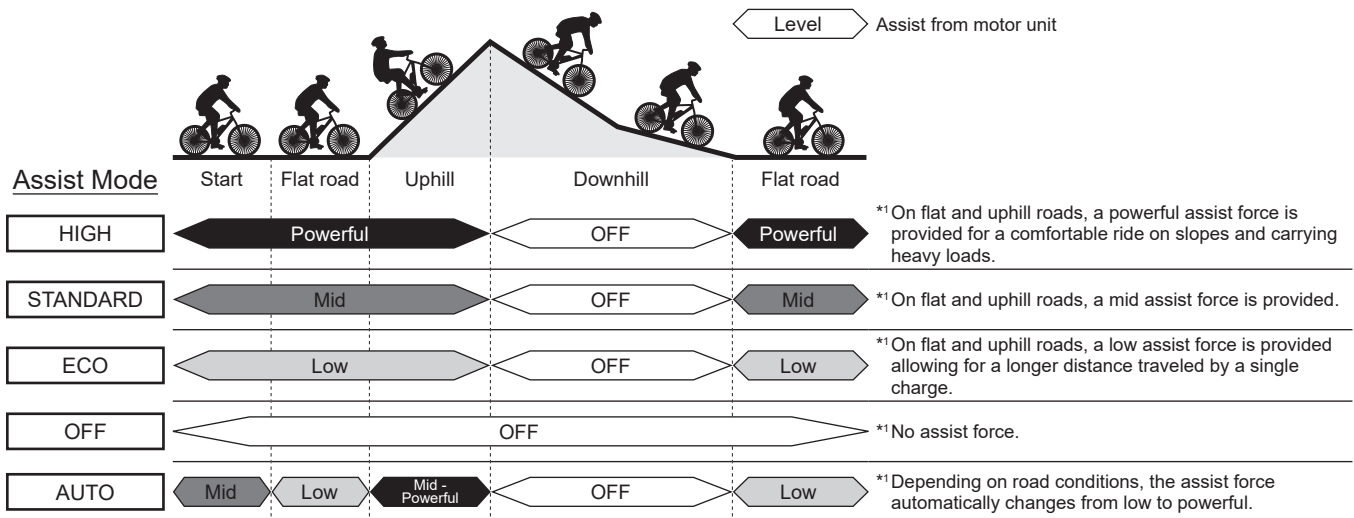

Press the assist mode select buttons (▲ / ▼) until the desired assist mode is displayed.

- Side display on the console: The assist mode selected in the assist mode display is displayed.

Bicycle mark button (Walk assistance)

This is the push-assistance function that assists you by providing drive up to 6 km/h, for example, when you are carrying a heavy load.

Hold down the bicycle mark button (Walk assistance).

- When you release your finger from the bicycle mark button (Walk assistance), or the electric bicycle exceeds a speed of 6 km/h, the function will not be activated.

Note

- When the pedals hit the curb or other objects and the push-assist function stops, hold down the bicycle mark button (Walk assistance) again.

Indication of speed, distance

The current speed is displayed at Speed indication at all times. (Fig. 3)

For the distance display and battery level, items and numerical values are displayed at Text indication and Value indication, respectively. (Fig. 3)

Items can be switched.

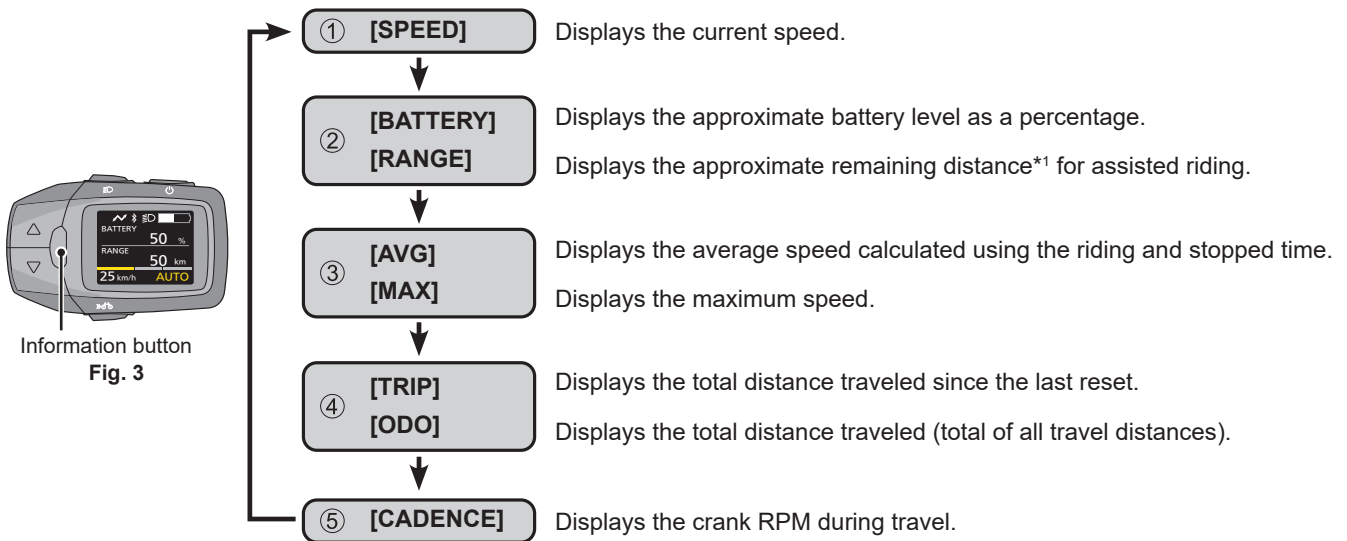

*¹ This is a rough value because the remaining battery capacity is calculated using the amount consumed.

Press the information button on the side display. (Fig. 3)

- Each press of the button switches the item.

■ If you want to simultaneously reset distance traveled (TRIP), average speed (AVG), and maximum speed (MAX)

- ① Use the information button to display [TRIP], [AVG] or [MAX].
- ② Hold the information button down until the display shows 0.
- •It is not possible to reset values individually.

Basic settings

Basic settings such as the language displayed on the side display, adjustment of backlight brightness and time can be changed. Access the basic setting menu, and change the settings as desired. In the basic setting menu, the following items can be switched and set.

Setting		Description
[DISPLAY]	[BRIGHTNESS]	The brightness of the backlight of the side display can be adjusted in 10 stages. The brightness can be set separately for when the night mode indicator is turned on and when it is turned off. *When light settings are disabled, the night mode indicator does not light up but the backlight switches.
	[LANGUAGE]	The language displayed on the side display can be switched. The language can be selected from the following ten languages: English, German, Dutch, French, Italian, Spanish, Danish, Slovak, Polish, Czech
[BIKE]	[UNIT]	The display unit for speed and distance can be toggled between kilometers and miles.
	[WHEEL]	The tire circumference matched to the electric bicycle currently in use can be set.
	[ODO]	The display of the total distance traveled can be changed.
[Bluetooth]	[CPP]	Uses the Cycle Power Profile to connect to the corresponding smartphone app.
	[NAVIGATION]	Hides and displays the navigation screen (komoot).
	[komoot]	Connects to komoot (smartphone app).
[CERTIFICATION]		Displays Technical Standards Conformity information.
[FACTORY RESET]		Resets the Side Display to factory settings.

Changing the settings and display

■ Operation method for the settings menu

- ① With the Side Display turned ON, press both the ▼ button and [information] button for more than 3 seconds.

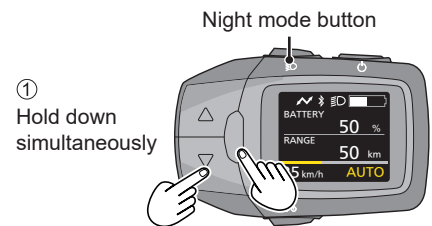

- ② Use the assist mode select buttons (▼ / ▲) to select the desired menu, and then press the [information] button.

- The system then enters the setting mode for the selected menu.

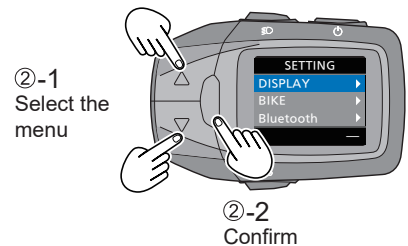

- ③ Use the assist mode select buttons (▼ / ▲) to change the settings, and confirm by pressing the [information] button.

- If you wish to continue configuring the settings, repeat steps ② and ③.

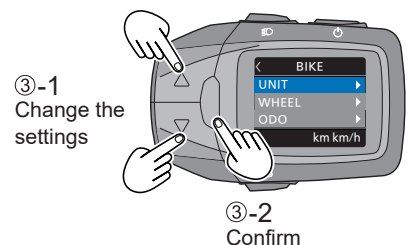

- ④ Press the night mode button

- The system returns to normal mode.

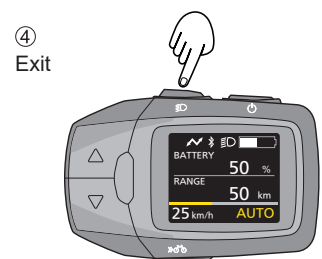

■ Configuring [DISPLAY] settings

Select [DISPLAY] from the settings menu, and then press the [information] button.

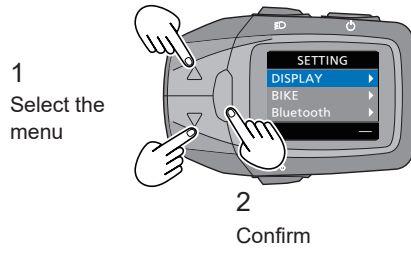

1) Setting [BRIGHTNESS]

① Use the assist mode select buttons (▼ / ▲) to select [BRIGHTNESS], and then press the [information] button.

- The current setting is displayed.

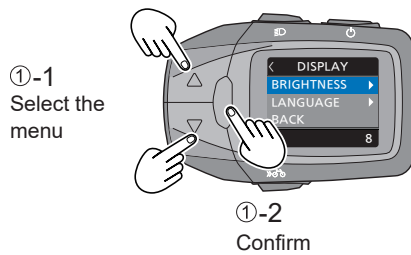

② Use the assist mode select buttons (▼ / ▲) to adjust the brightness, and then press the [information] button.

- Settings are changed.

Backlight brightness value options	Max: 10	Min: 1

You can adjust the brightness of the backlight for when lights are off and when lights are on.

Use the night mode button to select the state of the lights for which you want to configure the settings (i.e. when lights are on or off), and then use the settings menu.

2) Setting [LANGUAGE]

① Use the assist mode select buttons (▼ / ▲) to select [LANGUAGE], and then press the [information] button.

- The current setting is displayed.

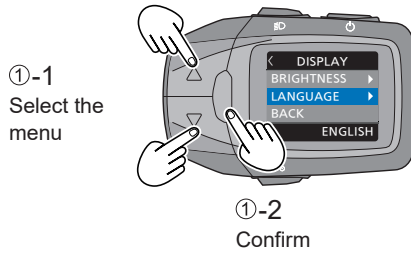

② Use the assist mode select buttons (▼ / ▲) to select the language, and then press the [information] button.

- Settings are changed.

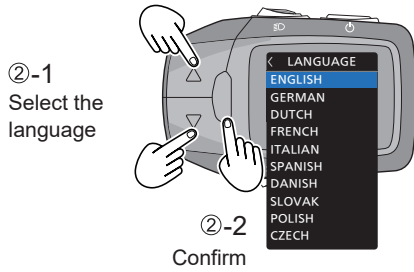

No.	Language
1	ENGLISH
2	GERMAN
3	DUTCH
4	FRENCH
5	ITALIAN
6	SPANISH
7	DANISH
8	SLOVAK
9	POLISH
10	CZECH

■ Configuring [BIKE] settings

Select [BIKE] from the settings menu, and then press the [information] button.

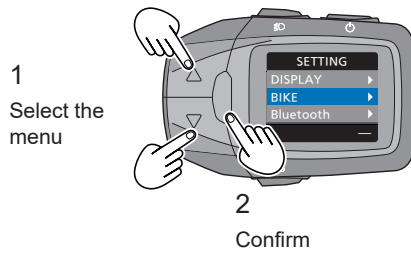

1) Setting [UNIT]

Perform this procedure to switch the units for speed and distance.

① Use the assist mode select buttons (▼ / ▲) to select [UNIT], and then press the [information] button.

- The current setting is displayed.

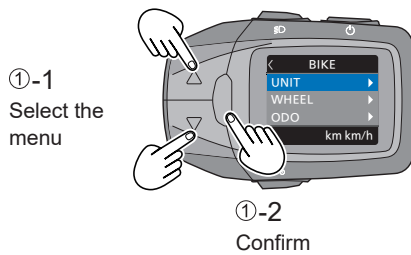

② Use the assist mode select buttons (▼ / ▲) to select the units, and then press the [information] button.

- Settings are changed.

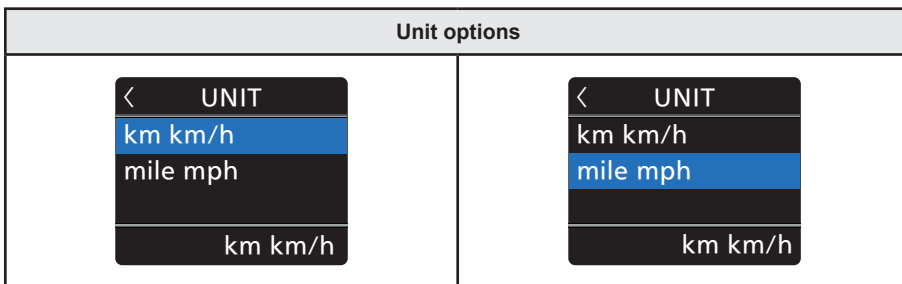

2) Setting [WHEEL]

Perform this procedure to set the tire circumference to match the tires on the bicycle.

① Use the assist mode select buttons (▼ / ▲) to select [WHEEL], and then press the [information] button.

- The current setting is displayed.

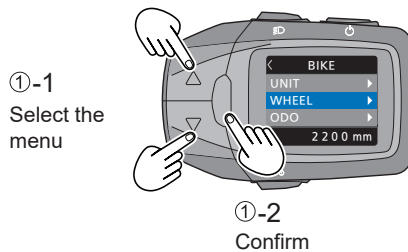

② Use the assist mode select buttons (▼ / ▲) to set the thousands place of the number for the circumference of the tires, and then press the [information] button.

- The settings changes, and the underbar moves to the hundreds place of the number. Repeat this process until you reach the ones place.

*Tire circumference is only saved if you set all places of the number.

*It is not possible to move the underbar back to a previous place.

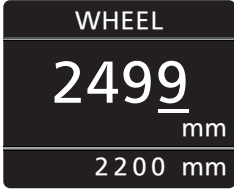
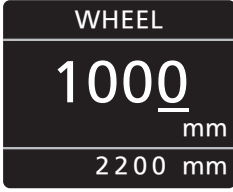
Tire circumference value input	Max: 2499	Min: 1000
		

Notifications

- The factory setting for tire circumference is 2200 mm. This must be changed if you change the tires on your bicycle.
- If you do not change this setting, speed and distance will not be accurately displayed.

3) Setting [ODO]

Perform this procedure to modify the total distance that is automatically displayed.

① Select [ODO] from the settings menu, and then press the [information] button.

- The current setting is displayed along with an underbar under the tens of thousands place of the new number.

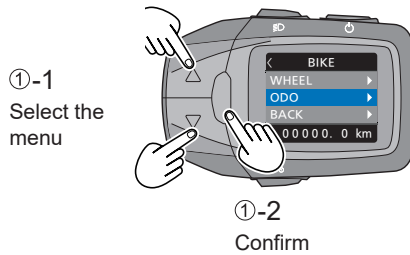



② Use the assist mode select buttons (▼ / ▲) to set the tens of thousands place of the total distance, and then press the [information] button.

- The settings changes, and the underbar moves to the thousands place of the number. Repeat this process to set the total distance to the first decimal place.

*The total distance is only saved if you set all places of the number.

*It is not possible to move the underbar back to a previous place.

Total distance value entry	Max: 99999.9	Min: 00000.0
		

■ Performing a factory reset

- ① Select [FACTORY RESET] from the settings menu and press the [information] button.
 - It is not possible to reset values individually.

■ Pairing with and connecting to a Bluetooth device

Preparations

- Ensure that the Bluetooth device is within 1 m of the Side Display.
- If necessary, check the operation method and other information in the user manual for the Bluetooth device.
- Turn the Bluetooth device on, and enable the Bluetooth function

- ① Select [Bluetooth] from the settings menu, and then press the [information] button.

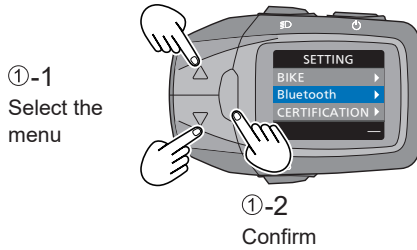

1) Setting [CPP]

Perform this procedure to pair with a device that supports CPP.

- ① Use the assist mode select buttons (▼ / ▲) to select [CPP], and then press the [information] button.
- ② Select [CONNECT] to start pairing with the Side Display.
 - While not connected: [CONNECT] and [BACK] are displayed.
 - While connected: [DISCONNECT] and [BACK] are displayed. Select [DISCONNECT] to cancel the pairing with the device that is currently connected.

*The **device name** for this device when paired is [Panasonic + 6 alphanumeric characters] as shown at the bottom of the CPP screen.

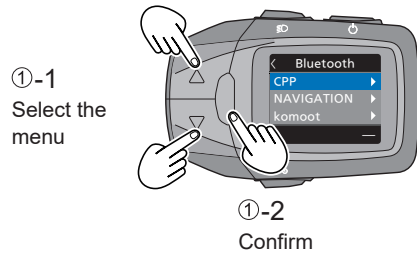

While not connected	While connected
<p style="text-align: center;">Device name</p>	

- ③ Start pairing on the Bluetooth device. On the Bluetooth device, select the device name [Panasonic + 6 alphanumeric characters].
- ④ Check that the Side Display and Bluetooth device are connected.

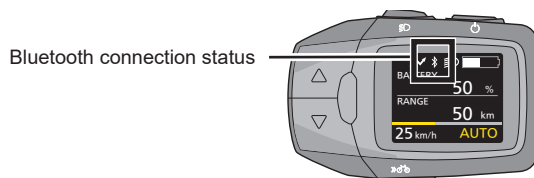

When using Bluetooth devices...

■ Specified frequency band

The 2.4 GHz frequency band used by this product is also used by industrial, scientific, and medical equipment such as microwave ovens, as well as premises radio stations (license required) used for identification of moving objects in factory production lines and in other such places, specified low-power radio stations (no license required), and amateur radio stations (license required).

- ① Before using this device, check that there are no premises radio stations used for identification of moving objects, specified low-power radio stations, or amateur radio stations nearby.
- ② If this device causes interference with premises radio stations used for identification of moving objects, you should immediately change the place you use it in or halt the use of radio waves.

■ Device certification

This device has received a Technical Standards Conformity Certification based on the Radio Act, so it does not require a radio station license. However, the following acts are punishable by law if performed on this device.

- Disassembly/modification

■ Usage limitations

- This device is not guaranteed to be able to communicate wirelessly with every Bluetooth® device.
- Any Bluetooth® device with which wireless communication is to be performed must be certified as compliant with the standards set by Bluetooth SIG, Inc. However, it may not be possible to connect to a device even if it is certified as being compliant with these standards due to its usage and settings, and no guarantees are made regarding the operating method, display, or operation.
- This device supports security functions that conform to Bluetooth® standards, but security may not be sufficient depending on the usage environment and details of the settings. Please be aware of this when using wireless communication.
- Please understand that Panasonic shall accept no responsibility for any data or information leaks that occur during wireless communication.

■ Usable range

Use a Bluetooth® device within 1 m of this device. The usable range may be shorter depending on whether the surrounding environment has any obstacles or any other devices that may cause interference. Please note that the usable range above is not guaranteed.

■ Impact from other devices

- Do not use the device in places where magnetic fields, static electricity, or radio wave interference occur. If used in the vicinity of the following, communication may be lost or experience delays.
 - Microwave ovens
 - Digital cordless telephones
 - Other devices that use radio waves in the 2.4GHz band (wireless audio devices, game consoles, etc.)
 - Metal objects and other such objects that are prone to reflecting radio waves
- In the vicinity of broadcasting stations and other such things where the radio waves in the periphery are very strong, the device may not work correctly.

■ Restrictions on purpose of use

This device assumes general usage, and it is not designed or manufactured for high-safety usage*. Do not use for any purpose that requires high safety.

* High-safety purposes refer to uses that require an extremely high level of safety in controls that involve a major direct risk to life or risk of injury.

Examples: Control of nuclear reactions in nuclear power facilities / automatic flight control in aircraft / air traffic control / transport control in high-volume shipment systems / medical devices for life support / missile launch control in weapons systems, etc.

2) Setting [NAVIGATION]

① Use the assist mode select buttons (▼ / ▲) to select [NAVIGATION], and then press the [information] button.

- When hidden: [ON] and [BACK] are displayed. When [ON] is selected, navigation information is displayed on the normal mode screen.

*Navigation is automatically set to ON when pairing with komoot is started.

- When shown: [OFF] and [BACK] are displayed. When [OFF] is selected, navigation information displayed on the normal mode screen is hidden.

*Navigation is not automatically switched OFF when pairing with komoot is cancelled.

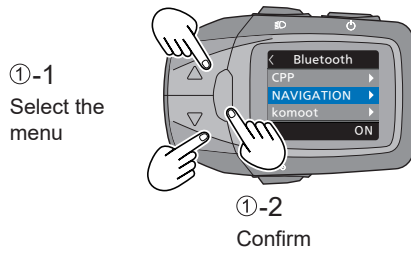

When hidden	When shown
<div style="border: 1px solid black; padding: 5px;"> <p>< NAVIGATION</p> <p>ON</p> <p>BACK</p> </div> <div style="border: 1px solid black; width: 40px; height: 20px; margin-left: auto; margin-top: 5px; text-align: center;">OFF</div> <p style="text-align: center;">Current status</p>	<div style="border: 1px solid black; padding: 5px;"> <p>< NAVIGATION</p> <p>OFF</p> <p>BACK</p> </div> <div style="border: 1px solid black; width: 40px; height: 20px; margin-left: auto; margin-top: 5px; text-align: center;">ON</div>

3) Configuring the [komoot] connection

Perform this pairing procedure to display the navigation information specified using the Side Display komoot app.

Smartphone

① Bluetooth Connect settings in smartphone komoot app

- From the device types, select [Panasonic Device].

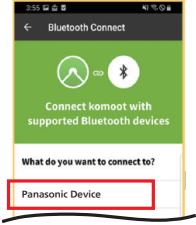

↓

② When the device is correctly recognized by your smartphone and the connected device appears on the app screen, pairing is complete.

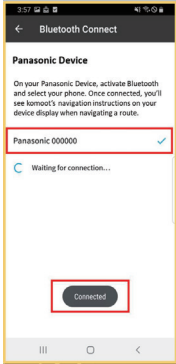

Side Display

① Select [komoot] from the settings menu, and then press the [information] button.

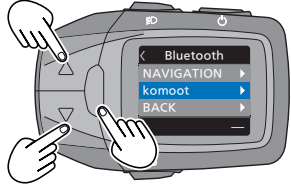

①-2
Confirm

② Select [CONNECT] from the komoot menu, and then press the [information] button.

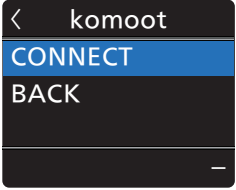

③ When your smartphone's name is recognized, select it and press the [information] button.

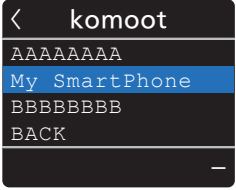

④ When pairing with your smartphone is completed successfully, [PAIRING SUCCESSFUL] is displayed and then a few seconds later the screen returns to the [Bluetooth] settings screen.



■ Precautions

- Even when following the instructions on a route by the navigation system, do not ignore road signs.
- The navigation system cannot take into account roadworks or temporary diversions.
- Even when using the navigation system, always follow the actual traffic rules.
- Depending on the communications environment, the distance shown by the navigation system may differ from the actual distance.
- Service contents provided by the app provider may be changed or stopped without notice due to the convenience of the app provider. We are not responsible for any damage or loss related to the change or termination of the service.

■ Checking [CERTIFICATION]

① Select [CERTIFICATION] from the settings menu, and then press the [information] button.

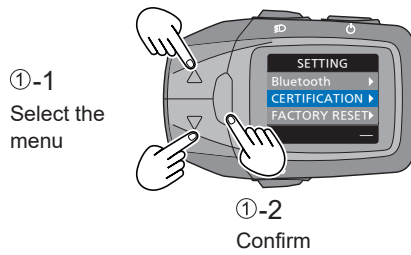

② On the [CERTIFICATION] screen, you can check the following details.

- Displays Technical Standards Conformity information for Japan. When you press the [information] button, the screen returns to the [SETTING] screen.



■ Performing a [FACTORY RESET]

① Use the assist mode select buttons (▼ / ▲) to select [FACTORY RESET], and then press the [information] button.

- [YES]: After restoring the Side Display to factory settings, the system returns to the [SETTING] screen.
- [NO]: The system returns to the [SETTING] screen.

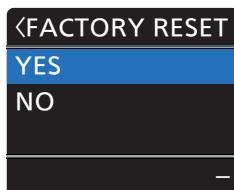
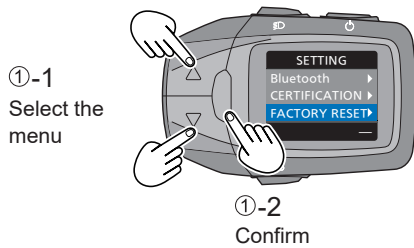

Item	Factory setting
BRIGHTNESS	Day mode: 8 Night mode: 4
LANGUAGE	ENGLISH
UNIT	km km/h
WHEEL	2200
ODO	0
TRIP	0
AVG	0
MAX	0
CPP	Not connected
NAVIGATION	Hidden
komoot	Not connected

Night mode button

Change the backlight brightness of the side display. Backlight setting has a normal mode and night mode. Five stages of brightness can be set for each mode.

In night mode, the brightness is lowered compared to normal mode so that glare can be reduced while travelling at night.

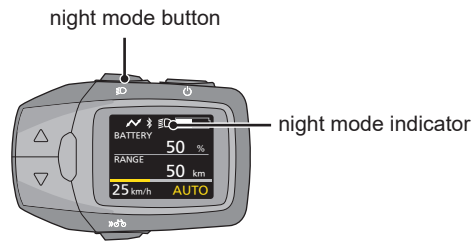

1) Press the power button.

- The electric bicycle system is turned on and the backlight of the side display lights in normal mode.

2) Press the night mode button.

- The night mode indicator is displayed on the side display and the backlight changes to night mode. To change to normal mode, press the night mode button again.

Note

- If you set the same brightness for both normal mode and night mode, the brightness does not change even when the mode is switched.
- Set the brightness of the normal mode while the night mode indicator is not displayed. Set the brightness of the night mode while the night mode indicator is displayed. (➔ page 9)
- Depending on the specifications of the completed bicycle, if the electric bicycle battery-powered head light or tail lamp is equipped, it will light in night mode.

Charging external devices

Charging external devices using the USB cable (optional)

You can charge external devices (e.g. mobile phones) that can be connected to the console via the USB cable. Connect the exclusive USB cable to charge for three hours.

External devices can be charged only when the side display of the console, and a charged battery are mounted on the electric bicycle. Also, the USB cable (commercially available) compatible with the external device is required.

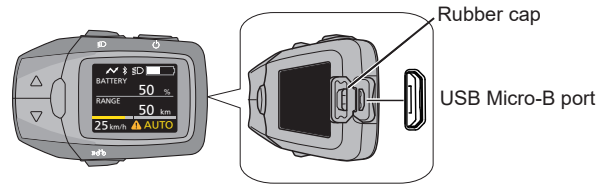

Fig. 1

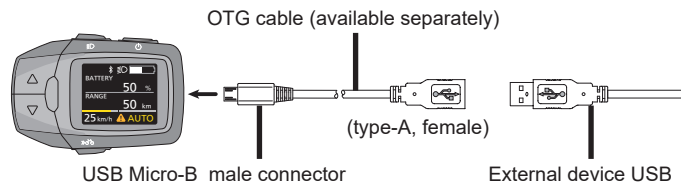

Fig. 2

- 1) Open the cover of the USB Micro-B port on the side display of the console. (Fig. 1)
- 2) Connect a separately purchased USB OTG cable to the USB Micro-B port.*
*Charging can only be performed using an OTG cable for USB Micro-B ports.
- 3) Connect the OTG cable and external device's USB cable.
- 4) When the Side Display and external device are connected via a USB cable, charging starts automatically.

Attention

- Do not place the external device on a tilted or unstable place while charging. Doing so may cause the device to fall and result a malfunction.
- Some external devices cannot be charged.
- Back up the internal data on the external device since there is the risk that it may disappear.
- Operation has only been verified with some external devices using the exclusive USB cable. There is no guarantee that your external device will work correctly.
- Do not charge external devices in rainy weather or connect a wet USB cable. Doing so may cause a malfunction.
- After using the USB Micro-B port, firmly close the rubber cap. Otherwise, water may seep in and cause malfunction.
- In order to prevent damage to the USB plug and USB cable, be sure to hold the plug when separating them.
- Do not apply excessive force to the USB plug or pull the USB cable.
- Check that the USB plug is facing the correct direction and has not become detached from the USB Micro-B port and is not misaligned.
- Do not put any foreign objects in the USB Micro-B port. Doing so can cause defects in the Side Display and external device.
- When charging a smartphone or other such device, please give sufficient consideration to safety and do not ride one-handed or look at the screen while riding.
- Charging may not be possible when the battery level is low.
- Please note that in the unlikely event that the contents of the memory of an external device are erased during use of the USB Micro-B port, Panasonic shall accept no responsibility whatsoever.
- Panasonic shall also accept no responsibility whatsoever concerning damaged caused by malfunctions or other problems resulting from the combination of connected devices.

Error codes

The parts of the electric bicycle system are monitored at all times during use and charging. If an error is detected, an error code will be displayed on the console. To return the console to the standard display, press any button on the side display of the console. Depending on the error code, motor unit drive is automatically stopped as necessary. The assist function will no longer be activated, though travel can be continued.

If the Side Display screen shows any of the following, check the details and take the action described.

■ Errors for which the warning icon is displayed in the bottom center of the screen



- If the warning icon is displayed, the details of the warning are displayed after the CADENCE screen when the [information] button is pressed to switch the display.

*If the navigation function is enabled, the screen changes in the order of CADENCE ⇨ Navigation screen ⇨ Warning screen.



Screen	Solution	Page
	<ul style="list-style-type: none"> • The drive unit is under an excessive load, and the system has entered protected mode. <ul style="list-style-type: none"> ⇨ Reduce speed variation to lighten the load during travel. After a short period of time, the temperature will return to normal and assistance will be restored. • When the system enters protected mode (when using in hot, sunny conditions, etc.), the assistance force is limited. However, you can continue to use your bicycle as normal. If the display does not come back on after a short period of time, please consult your dealer. 	—
	<ul style="list-style-type: none"> • This is an error in communication between the Side Display and the drive unit. <ul style="list-style-type: none"> ⇨ Contact your dealer for repair. 	—
	<ul style="list-style-type: none"> • The battery is under an excessive load, and the system has entered protected mode. <ul style="list-style-type: none"> ⇨ Reduce speed variation to lighten the load during travel. After a short period of time, the temperature will return to normal and assistance will be restored. • When the system enters protected mode (when using in hot, sunny conditions, etc.), the assistance force is limited. However, you can continue to use your bicycle as normal. If the display does not come back on after a short period of time, please consult your dealer. 	—
	<ul style="list-style-type: none"> • Communication with the battery is not being performed correctly. <ul style="list-style-type: none"> ⇨ Clean away any dirt from the battery terminals. If this does not solve the problem, consult your dealer. 	—
	<ul style="list-style-type: none"> • This is an error with the drive unit. <ul style="list-style-type: none"> ⇨ Contact your dealer for repair. 	—



— Error codes

 <p>W-0 S 1 - km/h ⚠️ AUTO</p>	<ul style="list-style-type: none"> • The speed sensor does not correctly detect the signal. ⇒ Turn the device off and then back on. If this does not solve the problem, consult your dealer. 	—
 <p>W-0 U 1 0 km/h ⚠️ AUTO</p>	<ul style="list-style-type: none"> • Protection for the USB power supply function is in effect. ⇒ Turn the device off and on again. If this does not solve the problem, this function cannot be used with your device. 	—
 <p>M2 B1 S1 C1 0 km/h ⚠️ AUTO</p>	<ul style="list-style-type: none"> • If multiple errors occur simultaneously, [W-0] is omitted and the error symbols are displayed in a list. Refer to the relevant error items for details. 	—

■ Other errors

- In the event of an error where assistance or walk assistance cannot be continued, the screen may display the following errors regardless of the warning icon.

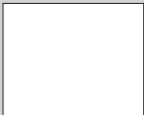
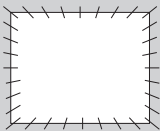
*The errors may be displayed along with the warning icon.

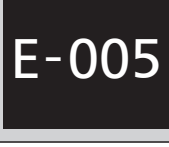
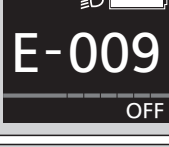
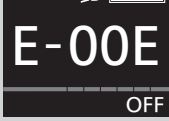
Screen	Solution	Page
	<ul style="list-style-type: none"> • If the screen goes completely white when you turn the Side Display on, this means a software error has occurred. ⇒ Contact your dealer for repair. 	—
	<ul style="list-style-type: none"> • If the screen flashes white after turning the power on, this means an EEPROM error has occurred. ⇒ Contact your dealer for repair. 	—
 <p>E-001 OFF</p>	<ul style="list-style-type: none"> • Were you standing on the pedal when you pressed the power button? ⇒ Turn the Side Display on by pressing the power button without standing on the pedal. 	—
 <p>E-003 ⚠️ OFF</p>	<ul style="list-style-type: none"> • Original battery (from time of purchase) not detected. ⇒ Load the original battery (from time of purchase). 	—
 <p>E-005</p>	<ul style="list-style-type: none"> • This is an error in communication between the Side Display and the drive unit. ⇒ Contact your dealer for repair. 	—
 <p>E-009 OFF</p>	<ul style="list-style-type: none"> • This is an error with the drive unit. ⇒ Contact your dealer for repair. 	—
 <p>E-00E OFF</p>	<ul style="list-style-type: none"> • There is a fault in an important component. ⇒ Remove your hand from the bicycle mark button and turn the power on. If this does not solve the problem, contact your dealer for repair. 	—

	<ul style="list-style-type: none"> • This is an error with the drive unit software. ⇒ Contact your dealer for repair. 	<p>—</p>
---	--	----------

Daily care

The parts of the electric bicycle system are precision parts and must be cared for daily.

Daily care

- Prevent all parts of the electric bicycle system from getting dirty. If parts are dirty, wipe off the dirt with a soft, moist cloth.
(Battery terminals and corresponding connectors, and terminals on the cradle and on the side display of the console)
- Before and after use, wipe any dirt or water from the terminals on the console or cradle.

Specifications

■ Console

Operating temperature	-10°C to 40°C
Storage temperature	-20°C to 50°C
Weight	Approx 120 g
Waterproofing level	IPX5
USB output	5 V DC, Max. 1 A
USB port	USB Micro-B
Communication type	Bluetooth version 5.0
Maximum power	8.0 dBm
Communication range	Up to 1 m approx.
Frequency band	2402-2480 MHz
Supported profiles	CPP (*1), komoot (*2)

*1 CPP (Cycling Power Profile)

*2 komoot (supports the komoot app)

Copyright

The Bluetooth® word mark and logo are registered trademarks of Bluetooth SIG, Inc. Panasonic Co., Ltd. uses this mark and logo under license. All other trademarks and registered trademarks are trademarks or registered trademarks of the relevant party.

In addition, the various names, company names, and product names in this manual are trademarks or registered trademarks of the relevant company. Please note that some ™ and ® marks are omitted in this manual.

After-sales service

Check with an authorized bicycle dealer if you have any questions about the electric bicycle system and its components.

Disposal of Old Equipment and Batteries Only for European Union and countries with recycling systems



These symbols on the products, packaging, and/or accompanying documents mean that used electrical and electronic products and batteries must not be mixed with general household waste.
For proper treatment, recovery and recycling of old products and used batteries, please take them to applicable collection points, in accordance with your national legislation.
End-users in Germany are legally obliged to return used batteries to appropriate collection points. Batteries can be returned to retailers free of charge.
In Spain, users are required to deliver batteries to the appropriate collection points. In all cases, this will be free of charge for users. The cost of environmental management of waste batteries and accumulators is included in the sale price.
By disposing of them correctly, you will help to save valuable resources and prevent any potential negative effects on human health and the environment.
For more information about collection and recycling, please contact your local municipality.
Penalties may be applicable for incorrect disposal of this waste, in accordance with national legislation.



Note for the battery symbol (bottom symbol):

This symbol might be used in combination with a chemical symbol. In this case it complies with the requirement set by the Directive for the chemical involved.

Declaration of Conformity (DoC)

Hereby, "Panasonic Cycle Technology Co., Ltd." declares that this product is in compliance with the essential requirements and other relevant provisions of Directive 2014/53/EU.

Customers can download a copy of the original DoC to our RE products from our DoC server:

<https://www.ptc.panasonic.eu/>

Contact to Authorised Representative:

Panasonic Marketing Europe GmbH, Panasonic Testing Centre,
Winsbergring 15, 22525 Hamburg, Germany

Manufactured by:

Panasonic Cycle Technology Co., Ltd.
13-13 Katayama-cho, Kashiwara City, Osaka 582-8501, Japan

Authorized Representative in Europe:

Panasonic Marketing Europe GmbH
Panasonic Testing Centre
Winsbergring 15, 22525 Hamburg, Germany